

STAR WARNING SYSTEMS®

2023



Star Warning Systems

D.O.T. • UTILITY • SECURITY • CONSTRUCTION

POLICE • FIRE • EMERGENCY

Emergency Vehicle Warning System



STAR SIGNAL
VEHICLE PRODUCTS®

Over 134 years of Excellence!

Welcome to our newest StarSignal® catalog!

Take a look at the new design layout

I am proud to be the fifth generation President of a company that continues to be the largest manufacturer of red and blue lights to the police and warning light industries in the United States. With some of the new LED products you will see in this new catalog, we have only added to the innovative lighting design you are accustomed to seeing from Star.

Star also achieved the ISO 9001:2015 certification in our production facility. We are a fully functional vertically integrated company.

Of course none of this would be possible without reliable and dedicated customers such as yourself that make our progress as a company possible, and we thank you for your continued support and loyalty. As you look through our new catalog, please give us a call, and one of our customer service people will be glad to answer all of your questions. Please also don't forget to check out our website www.starheadlight.com, for the most up to date information and products that we offer.



 **Warning:** Cancer and Reproductive Harm - www.P65Warnings.ca.gov

Phone Number: 585-226-9500
www.starheadlight.com



TABLE OF CONTENTS

Star X-Fire® LED Beacons	2 - 7
Star Halo® LED Beacons	8 - 12
Star Halo® Dual-Color LED Beacons	13 - 15
C2 LED Beacons	16 - 17
Compact LED Beacons	18 - 20
LED Lights	21 - 37
Star Constellation®	38 - 40
Remote Kits and Heads	41
LED Traffic Directors	42 - 46
Undercover LED Lights	47 - 48
Star Phantom®	49 - 52
Vehicle Specific Phantom Brackets	53
LED Mini-Bars	54 - 63
LED Lightbars	64 - 68
Vehicle Specific Hook Mount Kits	69 - 70
Star Alarm® Back-Up Alarms	71 - 76
Switch Panels & Switch Boxes	77 - 79
Worklights and Accessories	80
Ford F-Series Shelf Bracket	81
Sirens	82 - 93
Speakers	94 - 95
Index	96 - 98
Terms and Warranty Information	99

 **Warning:** Cancer and Reproductive Harm - www.P65Warnings.ca.gov

Toll Free Fax Line: 1-888-478-2797
www.starheadlight.com





266TCL



266TCLV



266TSL



266TSLV



266TSLM

266

- Star X-Fire® technology
- Twelve different selectable flash patterns in either of two phases, plus Steady-On
- S-Link System™ synchronizing capabilities with other Star LED units, hardwire only
- Extremely low current draw
- Durable polycarbonate, twist on/off lens
- Permanent mount options: Lightweight polycarbonate base with three-holed flange and 1" pipe mount or two-holed flange and 1" pipe mount
- Magnet mount options: Cig. plug (On/Off and Pattern Select) with either standard magnet or vacuum magnet

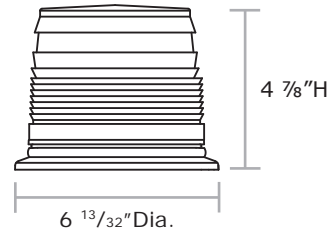
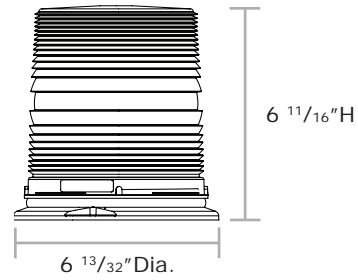

Flange Base

Base

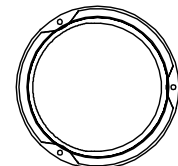
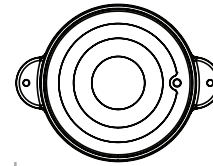

Part #	Description	Voltage	Amp Draw*	Weight	Approvals*
266TAL-*	Tall lens, dust cover, three hole, permanent mount	9-32V DC	0.5 amps @ 12V DC 0.3 amps @ 24V DC	3 lbs.	SAE Class I A, AC, C, R
266TASL-*	Short dome, dust dome, dust cover, three hole, permanent mount				Class II B
266TCFL-*	Tall lens, flange base, permanent mount				California Title 13
266TCL-*	Tall lens, three hole permanent mount				Tall SAE Class I A, AC, C, R
266TSFL-*	Short lens, flange base, permanent mount	9-16V DC	0.5 amps @ 12V DC 0.3 amps @ 24V DC	2 lbs.	Class II B
266TSL-*	Short lens, three hole permanent mount				Short SAE Class I A, AC, C
266TCLM-*	Tall lens, magnet mount				Class II B, R
266TSLM-*	Short lens, magnet mount	9-16V DC	0.5 amps @ 12V DC 0.3 amps @ 24V DC	6 lbs.	Short SAE Class I A, AC, C
266TCLV-*	Tall lens, vacuum magnet mount				Class II B, R
266TSLV-*	Short lens, vacuum magnet mount				Class II B, R

* Amp draw/Approvals will vary depending on the color of the LEDs and the flash pattern selected

Lens Colors



LED Colors with Clear domes



Branch Guards (Optional)

Black powder coated steel

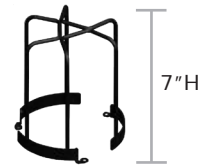

274-55TC

274-55TS

C - Tall branch guard, S - Short branch guard

Replacement Parts (* = color)

Tall Lens (266TCL)	295TC-*
Short Lens (266TSL)	295TS-*
Magnet mount kit	177-3
O-ring gasket	30047-41
Vacuum magnet mount	920-16V
Cig. plug	920-PAT20LO-EDGE

Warning: Cancer and Reproductive Harm - www.P65Warnings.ca.gov

Phone Number: 585-226-9500
www.starheadlight.com



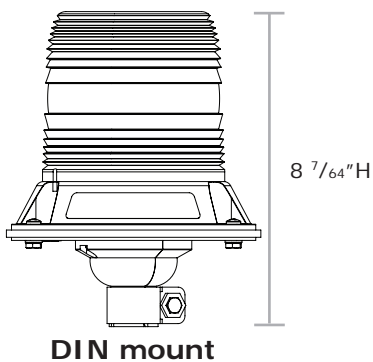
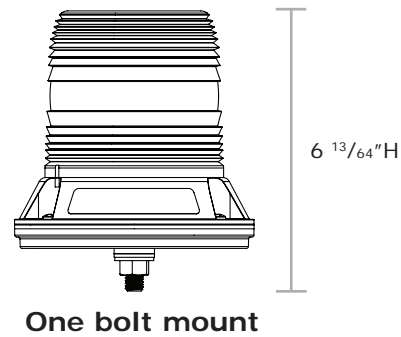
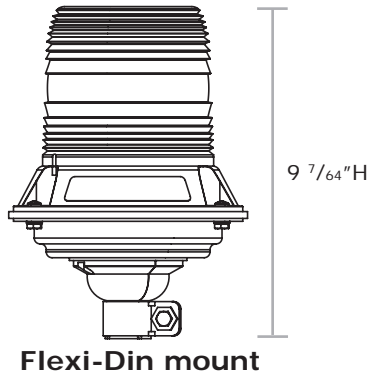
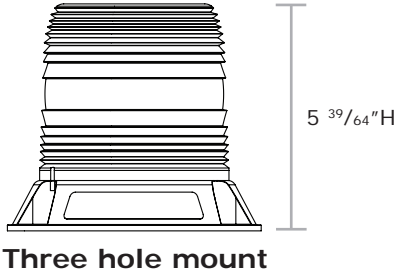

Replacement Parts (* = color)

Lens	P399*
Magnet mount kit	177-3
O-ring gasket	P30047-8
Vacuum magnet mount	920-16V
Cig. plug (281M)	920-PAT20LO-EDGE
Cig. plug (281RM)	S176-SWNL-EDGE



281-A



281-C



281-B

Base

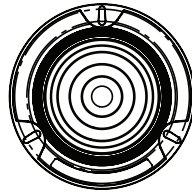

6 5/16" H



281DIN-C



281FDIN-B

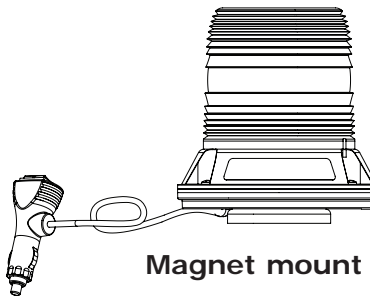

6 45/64" H

281

- Star X-Fire® LED technology
- Twelve different selectable flash patterns in either of two phases, plus Steady-On (excludes 281DIN, 281FDIN, 281RM models)
- Durable polycarbonate lens
- Lightweight, polycarbonate base
- Three bolt permanent mount, 12mm single bolt, magnet mount, DIN, and Flexi-DIN mount available
- Slotted mounting hole accommodates SAE and three bolt DIN mount
- S-Link System™ synchronizing capabilities (281, 281B, and 281R models only) with other Star LED units
- Sync. to alternating or simultaneous flash

Part #	Description	Voltage	Amp Draw*	Weight	Approvals*
281-*	Three-hole mount, selectable flash pattern, synchronizable	9-32V DC	0.5 amps @ 12V DC 0.3 amps @ 24V DC	3 lbs.	SAE Class I A
281B-*	Single bolt mount, selectable flash pattern, synchronizable			4 lbs.	
281DIN-*	Quad flash pattern only, DIN mount			6 lbs.	
281FDIN-*	Quad flash pattern only, flexi-DIN mount	10-16V DC		7 lbs.	SAE Class II B, C, R
281M-*	Selectable flash pattern, magnet mount			6 lbs.	
281R-*	Three-hole mount, selectable flash pattern, synchronizable includes rotating pattern			3 lbs.	
281RFP-*	Flexi-DIN mount with CCW rotating pattern only			7 lbs.	
281RM-*	Rotating pattern only, magnet mount			6 lbs.	SAE Class II Rotating Amber
281RP-*	DIN mount, slow rotating pattern only				

* Amp draw/Approvals will vary depending on the color of the LEDs and the flash pattern selected

Lens Colors



LED Colors



Warning: Cancer and Reproductive Harm - www.P65Warnings.ca.gov



Toll Free Fax Line: 1-888-478-2797
www.starheadlight.com





200A

- Star X-Fire® LED technology
- Twelve different selectable flash patterns in either of two phases, plus Steady-On
- S-Link System™ synchronizing capabilities with other Star LED units, hardwire only
- Extremely low current draw
- Durable polycarbonate inner lens and outer dome
- Clear, smooth, outer dome for easy cleaning and provides inner lens protection
- Heavy-duty spun aluminium base
- Universal mounting: permanent mount, 1" pipe mount

Mounting

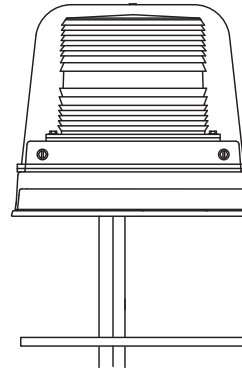

Base

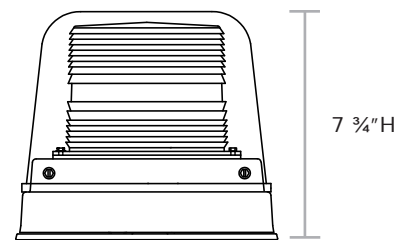
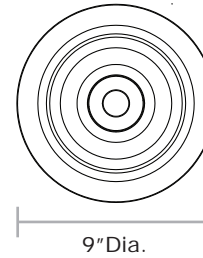

Part #	Description	Voltage	Amp Draw★	Weight	Approvals★
200A-12V-*	Warning beacon, permanent mount	9-32V DC	0.5 amps @ 12V DC 0.3 amps @ 24V DC	4 lbs.	SAE Class I A, AC, C

Replacement Parts (* = color)

Outer dome with holes	134-LD-*
Lens	300-*

★ Amp draw/Approvals will vary depending on the color of the LEDs and the flash pattern selected

Lens Colors



LED Colors with Clear domes



Warning: Cancer and Reproductive Harm - www.P65Warnings.ca.gov

Phone Number: 585-226-9500
www.starheadlight.com





200S



200SM

200S

Mounting

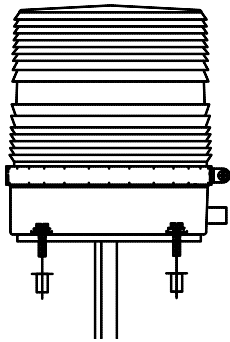

Base

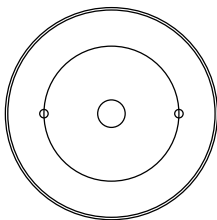

5 1/2" Dia.

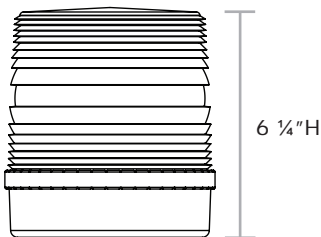

- Star X-Fire® LED technology
- Twelve different selectable flash patterns in either of two phases, plus Steady-On
- S-Link System™ synchronizing capabilities with other Star LED units, hardwire only
- Extremely low current draw
- Durable polycarbonate lens
- Rugged die-cast aluminium base with powder coated finish
- Universal permanent mount with 1/2" pipe mount, optional magnet mount with cig. plug (On/Off switch and Pattern Select)

Replacement Parts (* = color)

Lens	300-S-*
Base	4100LF-*
Clamp ring	365
Cig. plug	920-PAT20LO-EDGE
Magnet	177

Part #	Description	Voltage	Amp Draw*	Weight	Approvals*
200S-12V-*	Warning beacon, permanent mount	9-32V DC	0.5 amps @ 12V DC 0.3 amps @ 24V DC	3 lbs.	SAE Class I A, AC, C
200SM-12V-*	Warning beacon, magnet mount, cig. plug	9-16V DC	0.5 amps @ 12V DC	4 lbs.	

* Amp draw/Approvals will vary depending on the color of the LEDs and the flash pattern selected

Lens Colors



LED Colors



Warning: Cancer and Reproductive Harm - www.P65Warnings.ca.gov



Toll Free Fax Line: 1-888-478-2797
www.starheadlight.com





240C



240CF



240S



240SF

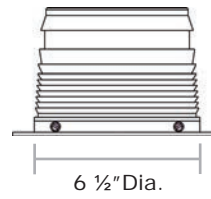

4 1/4"H

6 1/2" Dia.

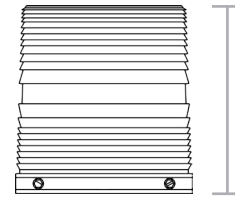

6"H

6 1/2" Dia.

Flange Base

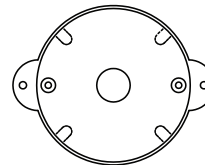

6 15/16"W

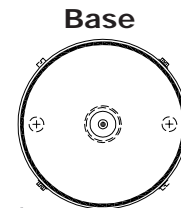

5 1/2" Dia.

Base

240

- Star X-Fire® LED technology
- Twelve different selectable flash patterns in either of two phases, plus Steady-On
- S-Link System™ synchronizing capabilities with other Star LED units (hardwire only)
- Extremely low current draw
- Durable polycarbonate lens
- 1" pipe mount base available with or without flange

Dust Cover (Optional)



296-C

5 3/4"H



296-S

4"H

C - Tall dome, S - Short dome

Branch Guards (Optional)

Black powder coated steel



274-40C

5 13/32"H



274-40S

4 1/2"H

C - Tall branch guard, S - Short branch guard

Part #	Description	Voltage	Amp Draw*	Weight	Approvals*
240C-12V-*	Tall lens, permanent mount, hardwire	9-32V DC	0.5 amps @ 12V DC 0.3 amps @ 24V DC	4 lbs.	SAE Class I A, C
240CF-12V-*	Tall lens, flange mount, hardwire				
240S-12V-*	Short lens, permanent mount, hardwire				
240SF-12V-*	Short lens, flange mount, hardwire				
240CM-12V-*	Tall lens, magnet mount, cig. plug	9-16V DC	0.5 amps @ 12V DC	5 lbs.	
240SM-12V-*	Short lens, magnet mount, cig. plug				

* Amp draw/Approvals will vary depending on the color of the LEDs and the flash pattern selected

Lens Colors



Replacement Parts (* = color)

Tall lens (240C)	295-*
Short lens (240S)	297-*
Magnet	177
Cig. plug	920-PAT20LO-EDGE

Warning: Cancer and Reproductive Harm - www.P65Warnings.ca.gov

Phone Number: 585-226-9500
www.starheadlight.com





201ZLXM



201ZLX

201ZLX

- Star X-Fire® LED technology
- Twelve different selectable flash patterns in either of two phases, plus Steady-On
- Durable ABS plastic base
- Permanent mount base with 1/2" pipe mount or magnet mount with cig. plug

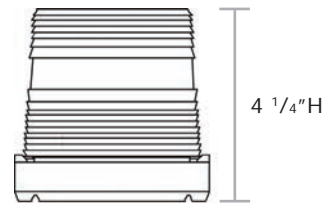

Mirror mount brackets (Optional)

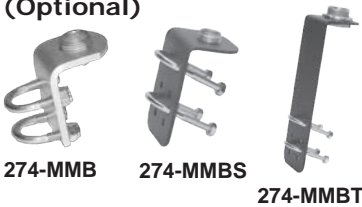

Replacement Parts (* = color)

Lens	330-*1
O-ring gasket	P30047-8
Magnet	177
Cig. plug with lighted On/Off switch	920-PAT20LO-EDGE
Eye shield	386

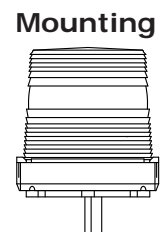
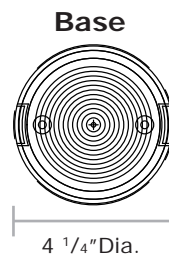

Part #	Description	Voltage	Amp Draw*	Weight	Approvals*
201ZLX-*	X-Fire®, permanent mount	9-32V DC	0.5 amps @ 12V DC 0.3 amps @ 24V DC	2 lbs.	SAE Class I A, B, C
201ZLXM-*	X-Fire®, magnet mount, cig. plug	9-16V DC		3 lbs.	SAE Class II R

* Amp draw/Approvals will vary depending on the color of the LEDs and the flash pattern selected

Lens Colors



Warning: Cancer and Reproductive Harm - www.P65Warnings.ca.gov



Toll Free Fax Line: 1-888-478-2797
www.starheadlight.com





255HTSL



255H8TAL



255H8TCL



255H

- Star Halo® LED technology is patented (#8,662,702)
- Twelve customer selectable flash patterns, plus Steady-On, and includes rotating
- S-Link System™ synchronizing capabilities with other Star LED units (hardwire versions only)
- Fully encapsulated circuitry for weather and shock resistance
- Extremely low current draw
- Durable polycarbonate, twist on/off lens
- Lightweight polycarbonate base with three-holed flange and 1" pipe mount or optional magnet mount (vacuum or standard magnets) with cig. plug

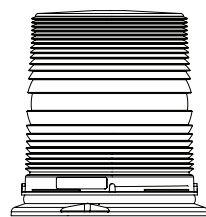

6 11/16" H

6 13/32" Dia.



4 7/8" H

6 13/32" Dia.

Flange Base

Base

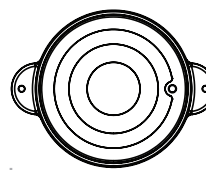

6 15/16" W

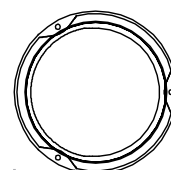

6 13/32" Dia.

Branch Guards (Optional)

Black powder coated steel



7" H



5 5/16" H

274-55TC

274-55TS

C - Tall branch guard, S - Short branch guard

Part #	Description	Voltage	Amp Draw★	Weight	Approvals★				
255H8TAL-A	Ultra high intensity LEDs, tall lens, dust cover, permanent mount, Amber	10-30V DC	0.7 amps @ 12V DC 0.4 amps @ 24V DC	3 lbs.	SAE Class I A				
255HTAL-A	High intensity LEDs, tall lens, dust cover, permanent mount, Amber		0.6 amps @ 12V DC 0.3 amps @ 24V DC			California Title 13			
255H8TCFL-*	Ultra high intensity LEDs, tall lens, flange mount, permanent mount		0.7 amps @ 12V DC 0.4 amps @ 24V DC	3 lbs.	H8CL SAE Class I A, R, B, C				
255H8TCL-*	Ultra high intensity LEDs, tall lens, permanent mount		0.6 amps @ 12V DC 0.3 amps @ 24V DC						
255HTCFL-*	High intensity LEDs, tall lens, flange mount, permanent mount		0.7 amps @ 12V DC 0.4 amps @ 24V DC						
255HTCL-*	High intensity LEDs, tall lens, permanent mount		0.6 amps @ 12V DC 0.3 amps @ 24V DC	2 lbs.		HCL SAE Class I A, AC, BC, C SAE Class II B, R, RC			
255H8TSFL-*	Ultra high intensity LEDs, short lens, flange mount, permanent mount		0.7 amps @ 12V DC 0.4 amps @ 24V DC						
255H8TSL-*	Ultra high intensity LEDs, short lens, permanent mount		0.6 amps @ 12V DC 0.3 amps @ 24V DC						
255HTSFL-*	High intensity LEDs, short lens, flange mount, permanent mount		10-16V DC	0.7 amps @ 12V DC 0.4 amps @ 24V DC			5 lbs.	H8SL SAE Class I A, R, B, C	
255HTCLM-*	Ultra high intensity LEDs, tall lens, magnet mount, cig. plug			0.6 amps @ 12V DC 0.3 amps @ 24V DC					
255H8TSLM-*	Ultra high intensity LEDs, short lens, magnet mount, cig. plug			0.7 amps @ 12V DC 0.4 amps @ 24V DC			4 lbs.		HSL SAE Class I A, AC, BC SAE Class II B, C, R, RC
255HTSLM-*	High intensity LEDs, short lens, magnet mount, cig. plug			0.6 amps @ 12V DC 0.3 amps @ 24V DC					
255H8TALV-A	California Title 13, ultra high intensity LEDs, tall lens, dust cover, vacuum magnet mount, cig. plug, Amber	10-16V DC	0.7 amps @ 12V DC 0.4 amps @ 24V DC	7 lbs.			255H8TAL Class I A, C		
255HTALV-A	California Title 13, high intensity LEDs, tall lens, dust cover, vacuum magnet mount, cig. plug, Amber		0.6 amps @ 12V DC 0.3 amps @ 24V DC						
255H8TCLV-*	Ultra high intensity LEDs, tall lens, vacuum magnet mount, cig. plug		0.7 amps @ 12V DC 0.4 amps @ 24V DC	7 lbs.					
255HTCLV-*	High intensity LEDs, tall lens, vacuum magnet mount, cig. plug		0.6 amps @ 12V DC 0.3 amps @ 24V DC						
255H8TSLV-*	Ultra high intensity LEDs, short lens, vacuum magnet mount, cig. plug		0.7 amps @ 12V DC 0.4 amps @ 24V DC		6 lbs.				
255HTSLV-*	High intensity LEDs, short lens, vacuum magnet mount, cig. plug		0.6 amps @ 12V DC 0.3 amps @ 24V DC						

Replacement Parts (* = color)

Tall lens (255HTCL)	295TC-*
Short lens (255HTSL)	295TS-*
Magnet mount kit	177-3
O-ring gasket	30047-41
Vacuum magnet mount	920-16V
Cig. plug	920-PAT20LO
Tall lens with dust cover	295TA-*

Colors for 4-LED version



C - Clear lens, colored LEDs

Colors for 8-LED version



★ Amp draw/Approvals will vary depending on the color of the LEDs and the flash pattern selected

⚠ Warning: Cancer and Reproductive Harm - www.P65Warnings.ca.gov

Phone Number: 585-226-9500

www.starheadlight.com



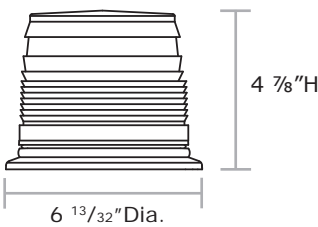
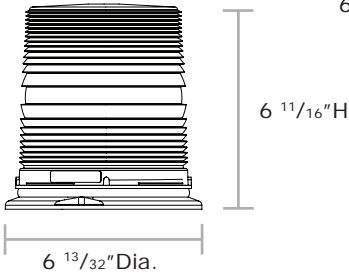
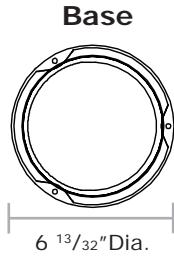

257HT*L

- Star Halo® LED Technology is patented (#8,662,702)
- Twelve customer selectable flash patterns, plus Steady-On, and includes rotating
- S-Link System™ synchronizing capabilities with other Star LED units (hardwire only)
- Fully encapsulated circuitry for weather and shock resistance
- Extremely low current draw
- Durable polycarbonate, twist on/off lens
- Die-cast metal, universal flange base with three-holed flange and 1" pipe mount or optional magnet mount (vacuum or standard magnets) with cig. plug

Branch Guards (Optional)
Black powder coated steel



274-55TC **274-55TS**
C - Tall branch guard, S - Short branch guard

Replacement Parts (* = color)

- Tall lens (257HTCL) 295TC-*
- Short lens (257HTSL) 297TS-*
- Vacuum magnet mount 920-16V
- O-ring gasket 30047-41
- Cig. plug 920-PAT20LO
- Tall lens with dust cover 295TA-*

Colors for 4-LED version



C - Clear lens, colored LEDs

Colors for 8-LED version



Part #	Description	Voltage	Amp Draw*	Weight	Approvals*
257H8TAL-A	Ultra high intensity LEDs, tall lens, dust cover, permanent mount	10-30V DC	0.7 amps @ 12V DC 0.4 amps @ 24V DC	3 lbs.	SAE Class I California Title 13
257HTAL-A	High intensity LEDs, tall lens, dust cover, permanent mount		0.6 amps @ 12V DC 0.3 amps @ 24V DC		
257H8TCL-*	Ultra high intensity LEDs, tall lens, permanent mount		0.7 amps @ 12V DC 0.4 amps @ 24V DC		
257HTCL-*	High intensity LEDs, tall lens, permanent mount		0.6 amps @ 12V DC 0.3 amps @ 24V DC	2 lbs.	H8CL SAE Class I A, R, B, C
257H8TSL-*	Ultra high intensity LEDs, short lens, permanent mount		0.7 amps @ 12V DC 0.4 amps @ 24V DC		
257HTSL-*	High intensity LEDs, short lens, permanent mount		0.6 amps @ 12V DC 0.3 amps @ 24V DC		
257H8TALV-A	Ultra high intensity LEDs, tall lens, dust cover, vacuum magnet mount, cig. plug, California Title 13	10-16V DC	0.7 amps @ 12V DC 0.4 amps @ 24V DC	7 lbs.	H8SL SAE Class I A, R, B, C
257HTALV-A	High intensity LEDs, tall lens, dust cover, vacuum magnet mount, cig. plug, California Title 13		0.6 amps @ 12V DC 0.3 amps @ 24V DC		
257H8TCLV-*	Ultra high intensity LEDs, tall lens, vacuum magnet mount, cig. plug		0.7 amps @ 12V DC 0.4 amps @ 24V DC		
257HTCLV-*	High intensity LEDs, tall lens, vacuum magnet mount, cig. plug		0.6 amps @ 12V DC 0.3 amps @ 24V DC	6 lbs.	HSL SAE Class I A, AC, BC SAE Class II B, C, R, RC
257H8TSLV-*	Ultra high intensity LEDs, short lens, vacuum magnet mount, cig. plug		0.7 amps @ 12V DC 0.4 amps @ 24V DC		
257HTSLV-*	High intensity LEDs, short lens, vacuum magnet mount, cig. plug		0.7 amps @ 12V DC 0.4 amps @ 24V DC		

* Amp draw/Approvals will vary depending on the color of the LEDs and the flash pattern selected

Warning: Cancer and Reproductive Harm - www.P65Warnings.ca.gov



Toll Free Fax Line: 1-888-478-2797
www.starheadlight.com





200AHL



200AHL

- Star Halo® LED technology is patented (#8,662,702)
- Twelve different selectable flash patterns in either of two phases, plus Steady-On
- S-Link System™ synchronizing capabilities with other Star LED units
- Fully encapsulated circuitry for weather and shock resistance
- Extremely low current draw
- Durable polycarbonate inner lens and outer dome
- Clear, smooth, outer dome for easy cleaning and provides inner lens protection
- Heavy-duty spun aluminium base with plastic base insert
- Universal mounting: permanent mount, 1" pipe mount with plastic base insert

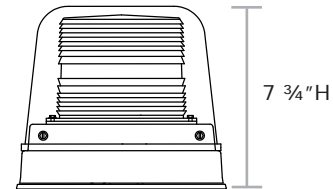

7 3/4" H

Base

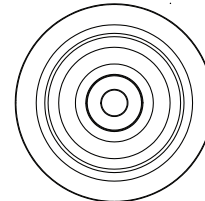

9" Dia.

Mounting

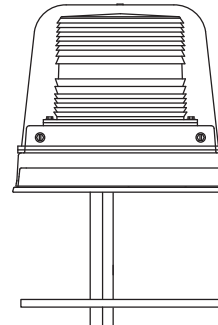

Part #	Description	Voltage	Amp Draw*	Weight	Approvals*
200AH8L-*	Ultra high intensity LEDs, tall lens, dust cover, plastic base insert	10-30V DC	0.7 amps @ 12V DC 0.4 amps @ 24V DC	4 lbs.	SAE Class I A, B, C California Title 13 A
200AHL-*	High intensity LEDs, tall lens, dust cover, plastic base insert		0.6 amps @ 12V DC 0.3 amps @ 24V DC		SAE Class I A, AC, C SAE Class II B, BC, R

Replacement Parts (* = color)

Outer dome with holes	134-LD-*
Inner lens	300-*
Plastic base insert	101-AP
Mounting kit	S278-6
Gasket	301

* Amp draw/Approvals will vary depending on the color of the LEDs and the flash pattern selected

Lens Colors



Inner Lens Colors



Warning: Cancer and Reproductive Harm - www.P65Warnings.ca.gov

Phone Number: 585-226-9500
www.starheadlight.com



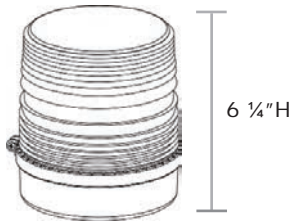

200SHL



200SHLM

200SHL

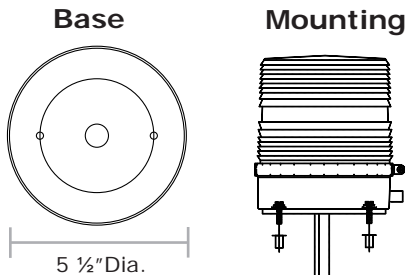

- Star Halo® LED technology is patented (#8,662,702)
- Twelve different selectable flash patterns in either of two phases, plus Steady-On
- S-Link System™ synchronizing capabilities with other Star LED units
- Extremely low current draw
- Durable polycarbonate lens
- Rugged die-cast aluminium base with powder coat finish
- Permanent mount with 1/2" pipe mount or optional magnet mount with cig. plug (On/Off switch and Pattern Select)

Mirror mount brackets (Optional)

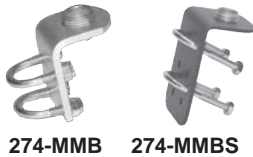

274-MMB 274-MMBS



274-MMBT

Replacement Parts (* = color)

Lens	300-S-*
Base	4100LF
Clamp ring	365
Cig. plug	920-PAT20LO
Magnet	177

Part #	Description	Voltage	Amp Draw*	Weight	Approvals*
200SH8L-*	Ultra high intensity LEDs, permanent mount	10-30V DC	0.7 amps @ 12V DC 0.4 amps @ 24V DC	4 lbs.	SAE Class I A, B, C, R
200SH8LM-*	Ultra high intensity LEDs, magnet mount, cig. plug	10-16V DC	0.7 amps @ 12V DC 0.4 amps @ 24V DC		
200SHL-*	High intensity LEDs, permanent mount	10-30V DC	0.6 amps @ 12V DC 0.3 amps @ 24V DC	5 lbs.	SAE Class I A, AC, C
200SHLM-*	High intensity LEDs, magnet mount, cig. plug	10-16V DC	0.6 amps @ 12V DC 0.3 amps @ 24V DC		

* Amp draw/Approvals will vary depending on the color of the LEDs and the flash pattern selected

Colors for 4-LED version



C - Clear lens, colored LEDs

Colors for 8-LED version



Warning: Cancer and Reproductive Harm - www.P65Warnings.ca.gov



Toll Free Fax Line: 1-888-478-2797
www.starheadlight.com





240HSFL



240HSL



240HCL



240*HL

- Star Halo® technology is patented (#8,662,702)
- Twelve different selectable flash patterns in either of two phases, plus Steady-On
- S-Link System™ synchronizing capabilities with other Star LED units
- Fully encapsulated circuitry for weather and shock resistance
- Extremely low current draw
- Durable polycarbonate lens
- Rugged die-cast aluminium base with powder coat finish
- Universal permanent mount, flange mount, 1" pipe mount, optional magnet mount with cig. plug (On/Off switch and Pattern Select)

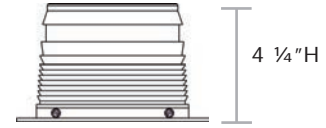
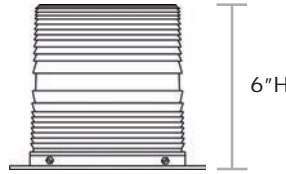

Part #	Description	Voltage	Amp Draw*	Weight	Approvals*
240H8AFL*	Ultra high intensity LEDs, dust cover, flange base, 1" pipe mount	10-30 V DC	0.7 amps @ 12V DC 0.4 amps @ 24V DC	2 lbs.	California Title 13 A
240H8AL*	Ultra high intensity LEDs, dust cover, 1" pipe mount				
240H8CFL*	Ultra high intensity LEDs, tall lens, flange base, 1" pipe mount		0.6 amps @ 12V DC 0.3 amps @ 24V DC	3 lbs.	H8L SAE Class I A, B, C, R HL SAE Class I A, AC, C SAE Class II B, BC, R, RC
240H8CL*	Ultra high intensity LEDs, tall lens, permanent mount, 1" pipe mount				
240HCFL*	High intensity LEDs, tall lens, flange base, 1" pipe mount		0.7 amps @ 12V DC 0.4 amps @ 24V DC	2 lbs.	
240HCL*	High intensity LEDs, tall lens, permanent mount, 1" pipe mount				
240H8SFL*	Ultra high intensity LEDs, short lens, flange base, 1" pipe mount		0.6 amps @ 12V DC 0.3 amps @ 24V DC	3 lbs.	
240H8SL*	High intensity LEDs, short lens, permanent mount, 1" pipe mount				
240HSFL*	High intensity LEDs, short lens, flange base, 1" pipe mount		0.7 amps @ 12V DC 0.4 amps @ 24V DC	4 lbs.	
240HSL*	High intensity LEDs, short lens, permanent mount, 1" pipe mount				
240H8CGL*	Ultra high intensity LEDs, tall lens, permanent mount, G-plate	0.6 amps @ 12V DC 0.3 amps @ 24V DC	5 lbs.		
240HCGL*	High intensity LEDs, tall lens, permanent mount, G-plate				
240H8SGL*	Ultra high intensity LEDs, short lens, permanent mount, G-plate	10-16V DC	0.6 amps @ 12V DC 0.3 amps @ 24V DC	California Title 13 A	
240HSGL*	High intensity LEDs, short lens, permanent mount, G-plate				
240H8ALM*	Ultra high intensity LEDs, dust cover, magnet mount				
240H8CLM*	Ultra high intensity LEDs, tall lens, magnet mount				
240HCLM*	High intensity LEDs, tall lens, magnet mount	5 lbs.	H8L SAE Class I A, B, C, R		
240H8SLM*	Ultra high intensity LEDs, short lens, magnet mount				
240HSLM*	High intensity LEDs, short lens, magnet mount		HL SAE Class I A, AC, C		
			SAE Class II B, BC, R, RC		

Flange Base

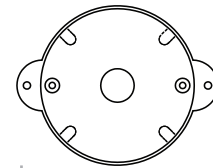

Base

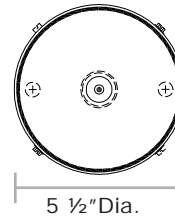

Mounting

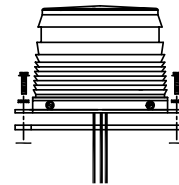

Branch Guards (Optional) Black powder coated steel

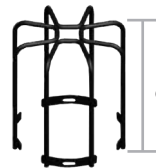

274-40C

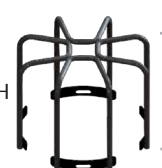

274-40S

C - Tall branch guard, S - Short branch guard

Dust Cover (Optional)



296-C



296-S

C - Tall dome, S - Short dome

Replacement Parts (* = color)

Tall lens (240C)	295-*
Short lens (240S)	297-*
Magnet	177
Cig. plug	920-PAT20LO

* Amp draw/Approvals will vary depending on the color of the LEDs and the flash pattern selected

Lens Colors



H8L LED Colors



HL LED Colors



Warning: Cancer and Reproductive Harm - www.P65Warnings.ca.gov

Phone Number: 585-226-9500
www.starheadlight.com





200ADHL

200AHDL

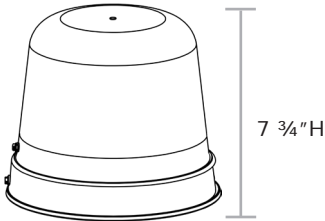

Mounting

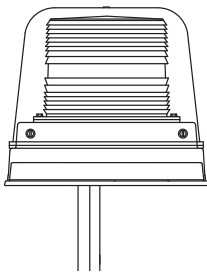

Base

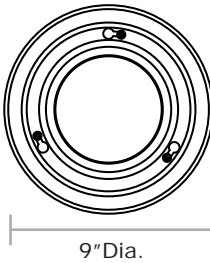

- Star Halo® LED technology is patented (#8,662,702)
- Dual-Color, Generation IV LEDs (four of each color)
- Twelve different selectable flash patterns in either of two phases, plus Steady-On
- Independent pattern select for each color
- S-Link System™ synchronizing capabilities with other Star LED units
- Extremely low current draw
- Durable polycarbonate inner lens and Clear outer dome
- Clear, smooth outer dome allows for easy cleaning and provides inner lens protection
- Heavy duty spun aluminium base with plastic base insert
- Universal mounting: permanent mount, 1" pipe mount with plate
- Ability to change the priority to have one enable override the other
- Ability to flash both colors with one switch

Replacement Parts (* = color)

Outer dome	134-LD-*
Inner lens	300-*
Plastic base insert	101-AP
Mounting kit	S278-6
Gasket	301

Part #	Description	Voltage	Amp Draw*	Weight	Approvals*
200AHDL-**	Dual-color, dust cover, Clear lens, permanent mount	10-30V DC	0.6 amps @ 12V DC 0.3 amps @ 24V DC	4 lbs.	SAE Class I AB, AC SAE Class II AR, RC, RB

* Amp draw/Approvals will vary depending on the color of the LEDs and the flash pattern selected

Dual-Color LED Colors



Inner Lens Color



Warning: Cancer and Reproductive Harm - www.P65Warnings.ca.gov



Toll Free Fax Line: 1-888-478-2797
www.starheadlight.com





200SHDL



200SHDLM

200SHDL

- Star Halo® LED technology is patented (#8,662,702)
- Dual-Color Generation IV LEDs (four of each color)
- Twelve customer selectable flash patterns including rotating patterns, plus Steady-On
- Individual pattern select for each color
- Ability to change the priority to have one enable override the other
- Ability to flash both colors with one switch
- S-Link System™ synchronizing capability with other Star LED units
- Extremely low current draw
- Fully encapsulated circuit for increased weather and shock resistance
- Rugged die-cast aluminium base
- Low voltage warning
- Permanent mount with ½" pipe mount or magnet mount with cig. plug (Dual On/Off switches)

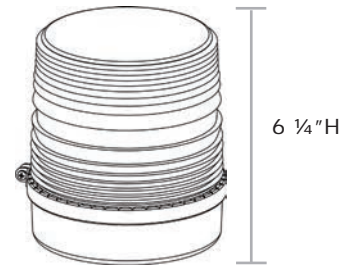

Mounting

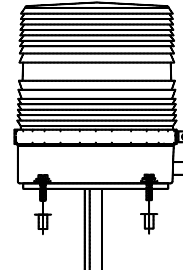

Base

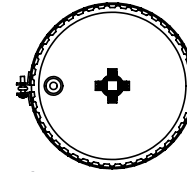

5 ½" Dia.

Part #	Description	Voltage	Amp Draw*	Weight	Approvals*
200SHDL-**	Dual-color, permanent mount	10-30V DC	0.6 amps @ 12V DC 0.3 amps @ 24V DC	4 lbs.	SAE Class I AB, AW
200SHDLM-**	Dual-color, magnet mount, cig. plug	10-16V DC		5 lbs.	

* Amp draw/Approvals will vary depending on the color of the LEDs and the flash pattern selected

Replacement Parts (* = color)

- Dome 300-S-*
- Magnet 30026-2
- Cig. plug S920-2PWR20
- Magnet 177
- mount kit

Dual-Color LED Colors



Lens Color



Warning: Cancer and Reproductive Harm - www.P65Warnings.ca.gov

Phone Number: 585-226-9500
www.starheadlight.com





258HTDCL



258HTDSL

258HTDL

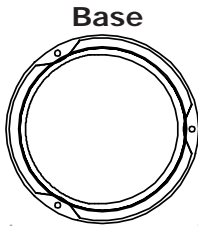

Base

6 13/32" Dia.

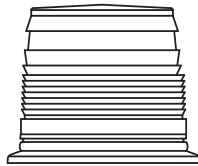

4 7/8" H

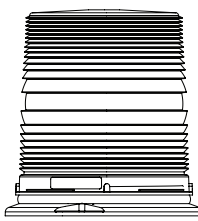

6 11/16" H

- Star Halo® LED technology is patented (#8,662,702)
- Dual-Color Generation IV LEDs (four of each color)
- Twelve customer selectable flash patterns including rotating patterns, plus Steady-On
- Individual pattern select for each color
- Ability to change the priority to have one enable override the other
- Ability to flash both colors with one switch
- S-Link System™ synchronizing capability with other Star LED units
- Extremely low current draw
- Fully encapsulated circuit for increased weather and shock resistance
- Lightweight polycarbonate, universal flange base: Three-hole permanent mount, 1" pipe mount
- Also available in vacuum magnet mount and cig. plug with dual power On/Off switch
- Low voltage warning

Branch Guards (Optional)
Black powder coated steel



7" H

274-55TC



5 5/16" H

274-55TS

C - Tall branch guard, **S** - Short branch guard

Replacement Parts (* = color)

- | | |
|---------------------------|-------------|
| Tall lens (255HTCL) | 295TC-* |
| Short lens (255HTSL) | 297TS-* |
| Tall lens with dust cover | 295TA-* |
| Magnet mount kit | 177-3 |
| O-ring gasket | 30047-41 |
| Vacuum magnet mount | 920-16V |
| Cig. plug | S920-2PWR20 |

Part #	Description	Voltage	Amp Draw*	Weight	Approvals*
258HTDAL-**	Dual-color, tall Clear lens, dust cover, permanent mount	10-30V DC	0.6 amps @ 12V DC 0.3 amps @ 24V DC	3 lbs.	SAE Class I AB, AW SAE Class II AR, RW
258HTDCL-**	Dual-color, tall Clear lens, permanent mount			2 lbs.	
258HTDSL-**	Dual-color, short Clear lens, permanent mount			2 lbs.	
258HTDALV-**	Dual-color, tall Clear lens, dust cover, vacuum magnet mount, cig. plug	10-16V DC		8 lbs.	
258HTDCLV-**	Dual-color, tall Clear lens, vacuum magnet mount, cig. plug			7 lbs.	
258HTDSL-**	Dual-color, short Clear lens, vacuum magnet mount, cig. plug			7 lbs.	

* Amp draw/Approvals will vary depending on the color of the LEDs and the flash pattern selected

Dual-Color LED Colors



Lens Color



Warning: Cancer and Reproductive Harm - www.P65Warnings.ca.gov



Toll Free Fax Line: 1-888-478-2797
www.starheadlight.com





256TCL



256TSL

256T*L

- Star X-Fire® technology
- Twelve different selectable flash patterns in either of two phases, plus Steady-On
- S-Link System™ synchronizing capabilities with other Star LED units, hardwire only
- Extremely low current draw
- Durable polycarbonate, twist on/off lens
- Permanent mount options: Lightweight polycarbonate base with three-holed flange and 1" pipe mount or two-holed flange and 1" pipe mount
- Magnet mount options: Cig. plug (On/Off and Pattern Select) with either standard magnet or vacuum magnet

Flange Base

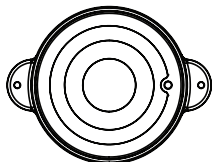

6 15/16" W

Base

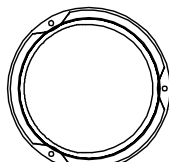

6 13/32" Dia.

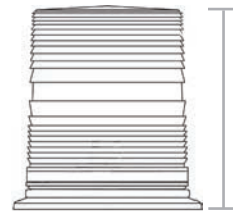

6 11/16" H

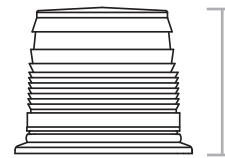

4 7/8" H

Part #	Description	Voltage	Amp Draw*	Weight	Approvals*
256TCFL-*	Tall lens, flange mount, permanent mount	9-32V DC	0.4 amps @ 12V DC 0.2 amps @ 24V DC	2 lbs.	SAE Class II A, B, C
256TCL-*	Tall lens, three hole permanent mount, 1" pipe mount				
256TSFL-*	Short lens, flange mount, permanent mount				
256TSL-*	Short lens, three hole permanent mount, 1" pipe mount				
256TCLM-*	Tall lens, magnet mount, cig. plug	10-16V DC		6 lbs.	
256TSLM-*	Short lens, magnet mount, cig. plug			5 lbs.	
256TCLV-*	Tall lens, vacuum magnet mount, cig. plug			8 lbs.	
256TSLV-*	Short lens, vacuum magnet mount, cig. plug			7 lbs.	

* Amp draw/Approvals will vary depending on the color of the LEDs and the flash pattern selected

Lens Colors



Branch Guards (Optional) Black powder coated steel



274-55TC

C - Tall branch guard, S - Short branch guard



274-55TS

Replacement Parts (* = color)

Tall lens (256TCL)	295TC-*
Short lens (256TSL)	297TS-*
Magnet mount kit	177-3
O-ring gasket	30047-41
Vacuum magnet mount	920-16V
Cig. plug	S920-PAT20LO-EDGE

Warning: Cancer and Reproductive Harm - www.P65Warnings.ca.gov

Phone Number: 585-226-9500
www.starheadlight.com





240CFL



240SFL



240CFL

240*FL

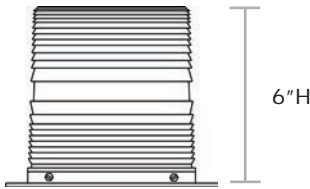

6"H

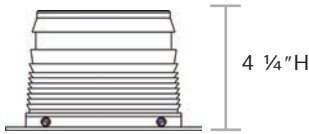

4 1/4"H

Flange Base

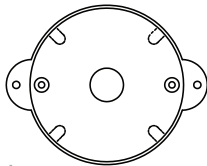

6 15/16"W

- Star Generation IV LEDs
- Twenty-six customer selectable flash patterns, including steady-on
- Screw mounted lens, rugged die-cast aluminium base with powder coat finish and universal mounting (permanent mount, flange mount, 1" pipe mount)

Dust Cover (Optional)



296-C

5 3/4"H



296-S

4"H

C - Tall dome, S - Short dome

Branch Guards (Optional)

Black powder coated steel



274-40C

6 13/32"H



274-40S

4 1/2"H

C - Tall branch guard, S - Short branch guard

Replacement Parts (* = color)

Tall lens (240C) 295-*

Short lens (240S) 297-*

Part #	Description	Voltage	Amp Draw*	Weight	Approvals*
240CFL-*	Tall lens, flange base, permanent mount	9-32V DC	0.4 amps @ 12V DC 0.2 amps @ 24V DC	3 lbs.	SAE Class II A, C
240SFL-*	Short lens, flange base, permanent mount			2 lbs.	

* Amp draw/Approvals will vary depending on the color of the LEDs and the flash pattern selected

Lens Colors



Warning: Cancer and Reproductive Harm - www.P65Warnings.ca.gov



Toll Free Fax Line: 1-888-478-2797
www.starheadlight.com





201ZL



201ZLM

201ZL

- Star Generation IV LEDs
- Twenty-six customer selectable flash patterns, including Steady-On and Cycle All
- Snap-on polycarbonate lens
- Durable ABS plastic base
- Permanent mount base with 1/2" pipe mount or magnet mount with cig. plug

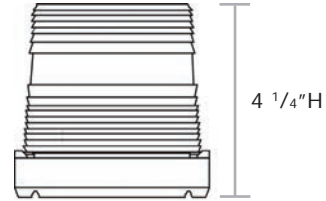

Mounting

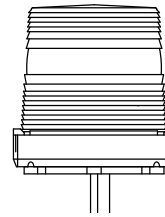

Base

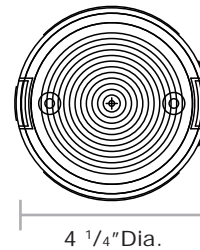

Mirror mount brackets (Optional)

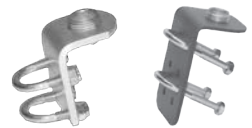

274-MMB

274-MMBS



274-MMBT

Part #	Description	Voltage	Amp Draw*	Weight	Approvals*
201ZL	Permanent mount, 1/2" pipe mount	9-32V DC	0.4 amps @ 12V DC	1.5 lbs.	SAE Class II A, C
201ZLM	Magnet mount, cig. plug	10-16V DC	0.2 amps @ 24V DC	2 lbs.	

* Amp draw/Approvals will vary depending on the color of the LEDs and the flash pattern selected

Lens Colors



Replacement Parts (* = color)

Lens	330-*1
O-ring gasket	P30047-8
Magnet	177
Cig. plug with lighted on/off switch	920-PAT20LO
Eye shield	386

Warning: Cancer and Reproductive Harm - www.P65Warnings.ca.gov

Phone Number: 585-226-9500
www.starheadlight.com





203MVL



203MVLM

203MVL

- Two Star Generation IV LEDs
- Twenty-six customer selectable flash patterns, including Steady-On and Cycle All
- Long life LEDs, rated for up to 100,000 hours
- Compact and powerful LED light output
- External pattern select wire (permanent mount only)
- Twist on/off lens
- Durable ABS plastic base
- Durable polycarbonate lens
- Flange permanent mount or magnet mount
- UL listed

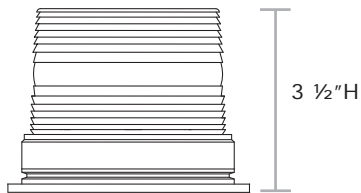

Mounting

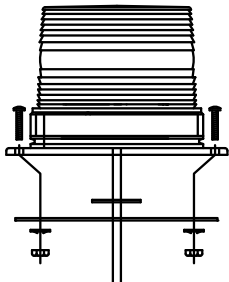

Base

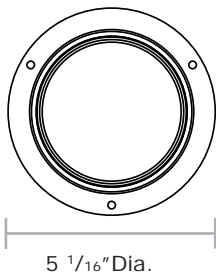

Replacement Parts (* = color)

Lens	320-*
Cig. plug	920-PAT20LO
Magnet	30026-3

Part #	Description	Voltage	Amp Draw*	Weight	Approvals*
203MVL-*	Flange base, permanent mount	10-110V DC	0.1 amps @ 12V DC	1 lb.	SAE Class II A
203MVLM-*	Flange base, magnet mount, cig. plug	10-16V DC		2 lbs.	SAE Class III B, C

* Amp draw/Approvals will vary depending on the color of the LEDs and the flash pattern selected

Lens Colors



Warning: Cancer and Reproductive Harm - www.P65Warnings.ca.gov



Toll Free Fax Line: 1-888-478-2797
www.starheadlight.com





204MVL

- Two Star Generation IV LEDs
- Twenty-six customer selectable flash patterns, including Steady-On and Cycle All
- Long life LEDs, rated for up to 100,000 hours
- Compact and powerful LED light output
- External pattern select wire
- Space saving solution
- Durable ABS plastic base
- Durable polycarbonate lens
- UL listed

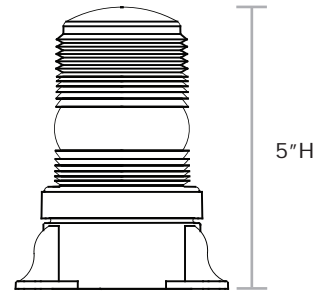

Mounting

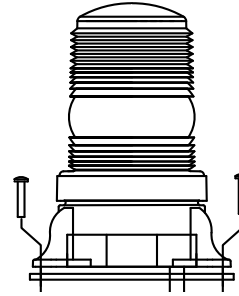

Base

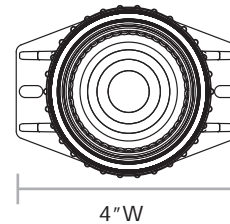

Part #	Description	Voltage	Amp Draw*	Weight	Approvals*
204MVL-*	5"H, LED beacon, flange mount	10-110V DC	0.1 amps @ 12V DC	1 lb.	SAE Class II A

* Amp draw/Approvals will vary depending on the color of the LEDs and the flash pattern selected

Lens Colors



Replacement Parts (* = color)

Lens 234-*

Warning: Cancer and Reproductive Harm - www.P65Warnings.ca.gov

Phone Number: 585-226-9500
www.starheadlight.com





ULB9E-RB

ULB9E



**Windshield Mount
ULB9-HOOD-1
(Included)**



**Headliner bracket
(sold separately)
274-ULB9CH**

- The ULB9E is perfect for undercover or unmarked vehicles
- Eight mid power LEDs
- Twelve customer selectable flash patterns, plus steady-on
- Hardwire version is available for S-Link System™ synchronizing capabilities with other Star LED units
- Flat front design hugs window for minimal flashback; great for side and rear vertical windows
- Ratchet clip mounts allow for angle adjustability
- Extremely lightweight!
- For interior applications only
- Slim profile
- US Patents (D710,726, D774,686, and 9,487,131)

**Mounting kit
sold separately**

274-ULB9BKT



Deck mount



Mirror mount



Suction cup

Replacement Parts

- Suction cup (one) DL15-CUP
- Complete universal mount kit 274-ULB9BKT
- Cig. plug (lighted On/Off switch with Pattern Select) P920-PAT20LO
- Optional hood for deck, mirror, or suction mounts ULB9-HOOD
- Hood kit with adhesive window mount ULB9-HOOD-1

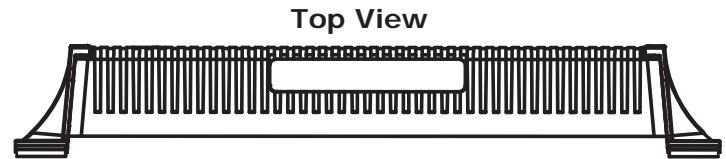

Top View

Side View

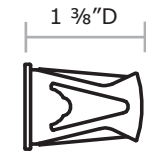

Front View

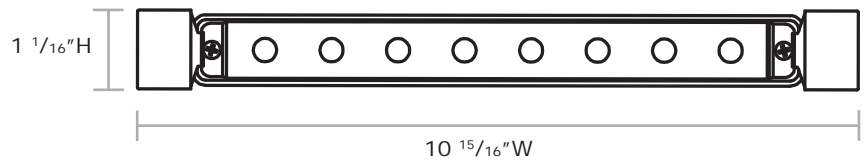

Part #	Description	Voltage	Amp Draw*	Weight	Approvals*
ULB9E-**	12' cord and cig. plug with On/Off and Pattern Select switches	10-16V DC	0.3 amps @ 12V DC	< 1 lb.	SAE Class I AB, RB
ULB9E-1.**	Hardwire, 12' cable, synchronizable				
RLKULB9E-1-**	Hardwire, two head kit with 12' cable				

* Amp draw/Approvals will vary depending on the color of the LEDs and the flash pattern selected

LED Colors



Warning: Cancer and Reproductive Harm - www.P65Warnings.ca.gov



Toll Free Fax Line: 1-888-478-2797
www.starheadlight.com



ULB9LDC-RRWW



Switch 1: Red



Switch 2: White

ULB9LDC

- The Lineum X™ technology offers an all **Dual-Color** and Dual Function mini interior light
- Twenty-four mid Power LEDs
- Flat front design hugs window for minimal flashback; great for side and rear vertical windows
- Ratchet clip mounts allow for maximum angle adjustability
- White takedown/pursuit lights
- Twelve patterns in each of two phases, plus Steady-On
- Split output functionality (Left/Right flashing) standard, programmable for "full" mode
- Independent user selectable color activation
- Extremely lightweight
- Hardware version is available for S-Link System™ synchronizing capabilities with other Star LED units
- US Patents (D710,726, D774,686, and 9,487,131)



Windshield Mount
ULB9-HOOD-1
(Included)



Headliner bracket
(sold separately)
274-ULB9CH

Top View

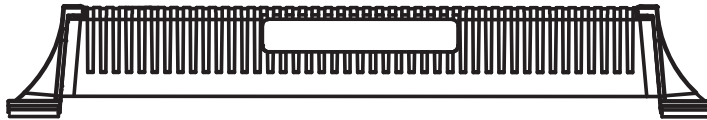

Front View

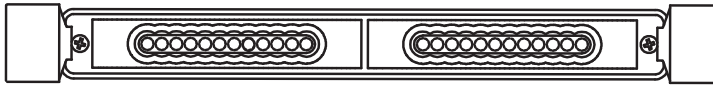

10 15/16" W

Side View

1 3/8" D



1 1/16" H

Part #	Description	Voltage	Amp Draw*	Weight	Approvals*
ULB9LDC-**	12' cord and cig. plug with dual On/Off switches	10-16V DC	0.6 amps @ 12V DC	< 1 lb.	SAE Class I A, B, R, W
ULB9LDC-1-**	Hardwired 12' cable, synchronizable				Class II RB

* Amp draw/Approvals will vary depending on the color of the LEDs and the flash pattern selected

LED Colors

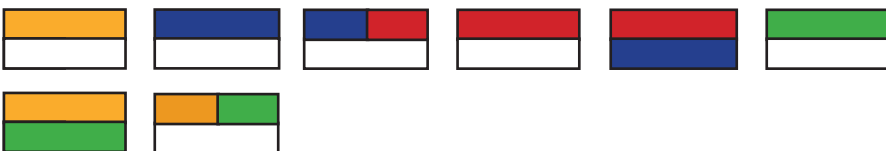

Mounting kit
sold separately
274-ULB9BKT



Deck mount



Mirror mount



Suction cup

Replacement Parts

Suction cup (one)	DL15-CUP
Complete universal mount kit	274-ULB9BKT
Cig. plug (dual power switch)	P920-2PWR20-17
Optional hood for deck, mirror, or suction mounts	ULB9-HOOD
Hood kit with adhesive window mount	ULB9-HOOD-1

Warning: Cancer and Reproductive Harm - www.P65Warnings.ca.gov

Phone Number: 585-226-9500
www.starheadlight.com





VL22

- LED Visor light with tilt switch
- Auto-Tilt™ Automatic Activation - automatically switches ON when visor is pulled down - automatically switches OFF when visor is lifted up
- Twenty-four different selectable flash patterns, plus Steady-On with the push of a button
- Cig. plug and Velcro straps standard - allows quick and easy installation from one vehicle to another
- Power indicator LED - shows ready status of visor light
- Reverse polarity protection
- Auto-Voltage Adjust - compensates for varying vehicle voltage
- High impact resistant polycarbonate housing

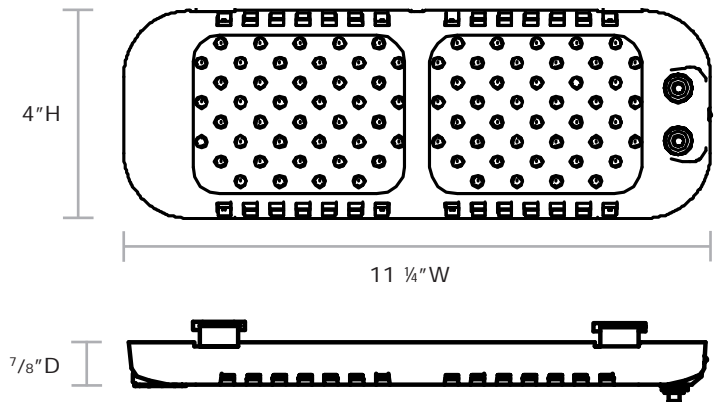

Part #	Description	Voltage	Amp Draw★	Weight	Approvals★
VL22	LED Visor Light with tilt switch	10-16V DC	1 amp @ 12V DC	1 lb.	SAE Class I A, B, R SAE Class III G, W

★ Amp draw/Approvals will vary depending on the color of the LEDs and the flash pattern selected

LED Colors



Warning: Cancer and Reproductive Harm - www.P65Warnings.ca.gov



Toll Free Fax Line: 1-888-478-2797
www.starheadlight.com





Micro-Star™

DLITDC

- High-intensity, Dual-Color LED auxiliary light
- Ultra thin profile bezel mount
- Dual-Color twelve super bright Star Generation V LEDs
- Twelve different selectable flash patterns in either of two phases
- Programmable full Steady-Burn or Cruise Mode for any color(s)
- Two independent enable lines, one for each color
- Programmable options for each enable line include Pattern, Phase, Steady Burn
- Can be controlled by an external flasher, acting as a dummy head
- Current limit protection over entire operating voltage
- New base without mounting ears allows sealed light to be independent from mounting stress forces by "floating" under mounting bezel
- Ultrasonic weld fuses lens to polycarbonate base providing maximum weather tight seal
- S-Link System 2.0™ synchronizing capabilities with other Star LED units (up to 10 units)
- IPx7 water protection

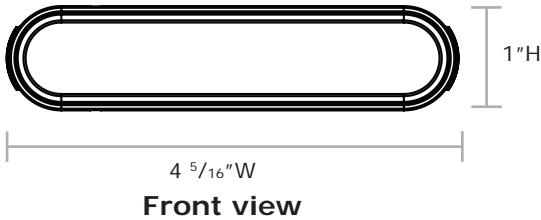

Part #	Description	Voltage	Amp Draw*	Weight	Approvals*
DLITDC.**	Dual-Color twelve LED head	10-16V DC	0.2 amps	< 1 lb.	SAE Class I

* Amp draw/Approvals will vary depending on the color of the LEDs and the flash pattern selected

LED Colors



Warning: Cancer and Reproductive Harm - www.P65Warnings.ca.gov

Phone Number: 585-226-9500
www.starheadlight.com



Micro-Star™



DLITE



DLIT3E



DLITS



DLIT3S

DLIT, DLIT3

- Ultra low profile
- DLITE, DLITS - six super bright Star Generation V LEDs
- DLIT3 - three super bright Star Generation V LEDs
- Twelve different selectable flash patterns in either of two phases, plus Steady-On
- S-Link System™ synchronizing capabilities with other Star LED units
- Current limit protection over entire operating voltage
- Robust design
- Standard four wire hook up (Power, Ground, Pattern, Sync.)
- Numerous mounting possibilities (See page 27)

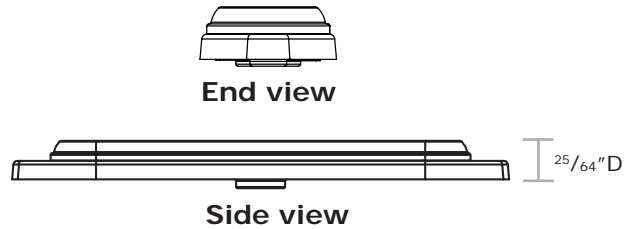
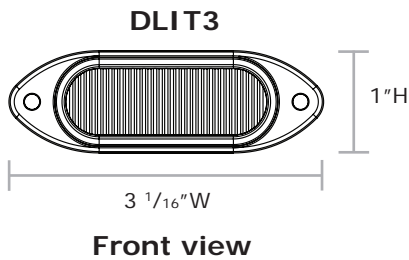
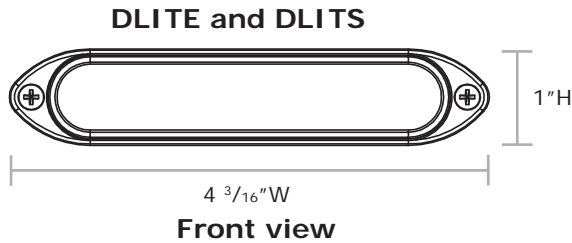

Part #	Description	Voltage	Amp Draw*	Weight	Approvals*
DLIT3E-*	Micro-star™ with a 3 LED array, widespread optics	10-16V DC	0.3 amps @ 12V DC	< 1 lb.	SAE Class II BW, RW, YB, YR
DLITE-**	Micro-star™ with a 6 LED array, widespread optics	10-30V DC	0.6 amps @ 12V DC		SAE Class I BB, RB, RR, WW, YY REG 10
DLIT3S-*	Micro-star™ with a 3 LED array, spot optics	10-16V DC	0.3 amps @ 12V DC		SAE Class I A, B, R, W
DLITS-**	Micro-star™ with a 6 LED array, spot optics	10-30V DC	0.6 amps @ 12V DC		SAE Class I BB, BW, RB, RR, RW, WW, YB, YR, YW, YY California Title 13 BB, RB, RR, YB, YR, YY

* Amp draw/Approvals will vary depending on the color of the LEDs and the flash pattern selected

Single Colors



Split Colors



Warning: Cancer and Reproductive Harm - www.P65Warnings.ca.gov



Toll Free Fax Line: 1-888-478-2797
www.starheadlight.com





Micro-Star™

DLITMC

- Ultra low profile
- Tri-Color: Eighteen super bright Star Generation V LEDs (six LEDs of each color)
- Eighteen different selectable flash patterns in either of two phases
- Built in ambient light sensor for optional Auto dim
- Programmable Cruise Mode (dim steady burn that is overridden by all other modes)
- Current limit protection over entire operating voltage
- Three independent enable lines, one for each color
- Programmable options for each enable line include Pattern, Phase, Multi-Color activation, Steady Burn, Cruise
- Easily programmed with either an Android or iPhone smartphone using our downloadable app or by using the included wires
- S-Link System 2.0™ synchronizing capabilities with other Star LED units
- Robust design utilizing a heavy duty die cast aluminium base
- Can be mounted to just about any flat surface
- Numerous mounting possibilities (see page 27)



Side view

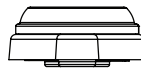

End view

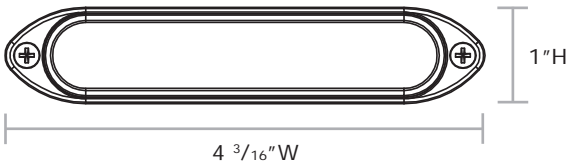

Front view

Part #	Description	Voltage	Amp Draw*	Weight	Approvals*
DLITMC-***	Tri-Color eighteen LED array	9-32V DC	0.8 amps @ 12V DC	< 1 lb.	SAE Class I RBW, RBA, RAW, ABW, AW

* Amp draw/Approvals will vary depending on the color of the LEDs and the flash pattern selected

How to video for slide switch application
<http://youtube.com/watch?v=VcpFbbCAXNk>

How to video for non-slide switch application
<http://youtube.com/watch?v=Zlxh7qZD1XE>

Dual Color



Tri Colors



Warning: Cancer and Reproductive Harm - www.P65Warnings.ca.gov

Phone Number: 585-226-9500
www.starheadlight.com





274-DLIT3-U



274-DLIT-U

Micro-Star™ Optional Brackets



274-DLIT-45



274-DLIT-CLP



274-DLIT-GRL



274-DLIT-GTA



274-DLIT-LPB4



274-DLIT-RB



274-DLIT-RL



274-DLIT-RT

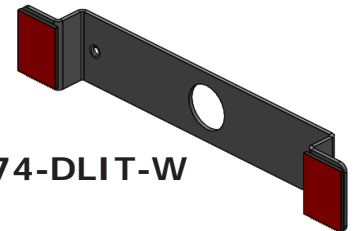

274-DLIT-W



BB274-FISUV-DLIT3

Part #	Description	Weight
274-DLIT-45	45° bracket kit for DLIT's	1 lb.
274-DLIT-CLP	Hood clip bracket for two DLIT's	1 lb.
274-DLIT-GRL	Grill bracket for DLIT's	
274-DLIT-GTA	2022 Chevy Tahoe grille bracket for DLIT's	
274-DLIT-LPB4	License plate bracket for four DLIT's	2 lbs.
274-DLIT-RB	2022 Chevy Tahoe running board bracket for DLIT's	1 lb.
274-DLIT-RL	License plate bracket for two DLIT's	2 lbs.
274-DLIT-RT	Adhesive bracket for DLIT's	1 lb.
274-DLIT-U	Universal bracket for DLIT's	
274-DLIT3-U	Universal bracket for DLIT3's	
274-DLIT-W	Window adhesive bracket for DLIT's	
BB274-FISUV-DLIT3	Ford Interceptor SUV front grille bracket kits for DLIT3 lights	< 1 lb.

Warning: Cancer and Reproductive Harm - www.P65Warnings.ca.gov



Toll Free Fax Line: 1-888-478-2797
www.starheadlight.com





DLS306-B



DLS306W-C



DLS306

- Maximum light output in a minimum package
- Six Star Generation IV LEDs
- Twelve different selectable flash patterns in either of two phases, plus Steady-On
- NEW steady burn override option
 - Single color flashing, steady White override
 - Both colors flashing, steady White override
 - Both colors flashing, White steady while other color remains flashing
- LED colors are now intermixed, allowing truer dual color effect
- S-Link System™ synchronizing capabilities with other Star LED units
- Fully encapsulated circuitry within the housing for vibration and water resistance
- Lens has diffusing optics for wider coverage
- Can mount just about anywhere and mount in any direction
- Built-in flasher
- Interior/exterior mount
- Kit includes a snap-on polycarbonate Black (standard), Chrome, or White bezel that will hide screw heads for a clean install

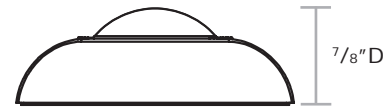
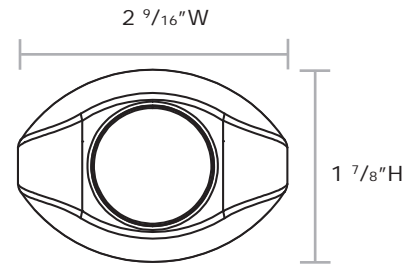

Mounting

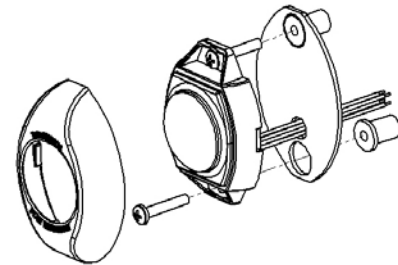

Replacement Parts

Black bezel	P30019-144B
Chrome bezel	P30019-144P
White bezel	P30019-144W

Part #	Description	Voltage	Amp Draw★	Weight	Approvals
DLS306-**	Mini-Comet™, Black bezel	10-30V DC	0.9 amps @ 12V DC	< 1 lb.	N/A
DLS306C-**	Mini-Comet™, Chrome bezel				

Installation on a metal surface is highly recommended for proper heat dissipation, allowing the light to obtain full brightness

★ Amp draw/Approvals will vary depending on the color of the LEDs and the flash pattern selected

Single Colors



Two Color



Warning: Cancer and Reproductive Harm - www.P65Warnings.ca.gov

Phone Number: 585-226-9500
www.starheadlight.com





DLX3-B



DLX4-RR



DLX6F-BB

DLX



Mounting

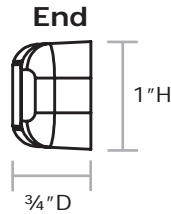

DLX3, DLX4, DLX6, DLX6F

- High intensity Star Generation IV LEDs
- Twelve different selectable flash patterns in either of two phases, plus Steady-On
- S-Link System™ synchronizing capabilities with other Star LED units
- Versatile LED warning lights that are built with fully encapsulated circuitry
- For use in both interior or exterior applications
- Reverse polarity protected and current limit protection over the entire operating voltage
- Designed for flush or bracket mount
- DLX6 - includes hood mount kit
- Includes a snap on Black (standard), Chrome, or White bezel
- Optional mounting brackets available (see page 30)

Part #	Description	Voltage	Amp Draw*	Weight	Approvals*
DLX3-*	Three LED, standard Black bezel	10-16V DC	0.2 amps @ 12V DC	< 1 lb.	SAE Class I A, R SAE Class II B, W Reg 10
DLX4-**	Four LED, standard Black bezel	10-30V DC	0.7 amps @ 12V DC		SAE Class I A, W Reg 10
DLX4C-**	Four LED, standard Chrome bezel				
DLX6-**	Six LED, standard Black bezel, includes 274-DLX4-6-CLP hood mount kit		0.9 amps @ 12V DC		SAE Class I A, AB, AR, AW, B, BW, R, RB, RW, W
DLX6C-**	Six LED, standard Chrome bezel, includes 274-DLX4-6-CLP hood mount kit				California Title 13 A, AB, AR, B, RB, R
DLX6F-**	Six LED, standard Black bezel				

* Amp draw/Approvals will vary depending on the color of the LEDs and the flash pattern selected

Replacement Parts

- Black bezel 30019-150B
- Chrome bezel 30019-150P
- White bezel 30019-150W
- Hardware kit for DLX3, DLX4, DLX6F S30017-38
- Hood Clamp Hardware kit for DLX6 274-DLX4-6-CLP
- Snap in medium spread optic 136-4
- Snap in wide spread optic 136-6

DLX3 Colors



DLX4 Colors



DLX6 Colors



Warning: Cancer and Reproductive Harm - www.P65Warnings.ca.gov



Toll Free Fax Line: 1-888-478-2797
www.starheadlight.com





BB274-DLX-VC

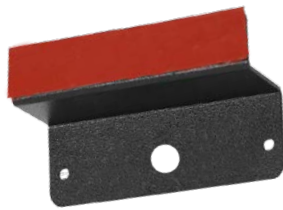

274-DLX4-6-W

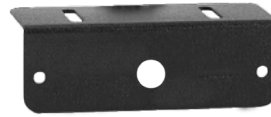

274-DLX4-6-U



274-DLX4-6-45



274-DLX4-6-1X2



BB274-DLX4-6-SLP



BB274-DLX46LPM



274-DLX4-6-RL



BB274-DLX6-BAIL



274-DLIT-LPB4



BB274-RWL



BB274-DLX4-6-RHK

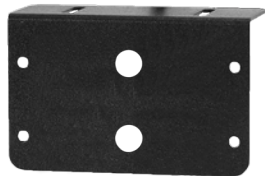

274-DLX4-6-2X1



274-DLX4-6-CLP



274-DLX4-6-T



274-DLX4-6-H

Versa Star® Optional Brackets

Part #	Description	Weight
274-DLIT-LPB4	License plate bracket, holds four lights	2 lbs.
274-DLX4-6-1X2	L-bracket for mounting two Versa Star® horizontally	
274-DLX4-6-2X1	L-bracket for mounting two Versa Star® vertically	1 lb.
274-DLX4-6-45	45° angle mounting bracket	
274-DLX4-6-CLP	Hood clip mounting bracket	
274-DLX4-6-H	Headliner bracket (fits both the standard Versa Star® lights and the *-HK hooded models)	2 lbs.
274-DLX4-6-HK	Headliner mounting bracket for DLX4 and DLX6	2 lbs.
274-DLX4-6-RL	License plate bracket, holds two lights	2 lbs.
274-DLX4-6-T	Trunk mounting bracket	1 lb.

Part #	Description	Weight
274-DLX4-6-U	Universal mount L-bracket	1 lb.
274-DLX4-6-W	Window mounting bracket	
BB274-DLX46LPM	Adjustable license plate mounting bracket	2 lbs.
BB274-DLX4-6-RHK	Pickup rear window mounting bracket using clothes hanger clips	1 lb.
BB274-DLX4-6-SLP	Pickup rear window mounting bracket	
BB274-DLX6-BAIL	Bail mounting bracket	2 lbs.
BB274-DLX-VC	Visor clip mounting bracket	1 lb.
BB274-RWL	Rear window bracket	

Warning: Cancer and Reproductive Harm - www.P65Warnings.ca.gov

Phone Number: 585-226-9500
www.starheadlight.com





DLX6-HK-BB



DLX4-HK2-BB



DLX6-HK2-BB



DLX4-HK-RR

DLX4-HK, DLX6-HK

- High intensity Star Generation IV LEDs
- Ten different selectable flash patterns in either alternating or simultaneous mode, plus Steady-On
- S-Link System™ synchronizing capabilities with other Star LED units (hardwire versions only)
- Versatile LED warning lights that are built with fully encapsulated circuitry
- For use in both interior or exterior applications
- Reverse polarity protected and current limit protection over the entire operating voltage
- Shipped with a flashback hood and includes a cig. plug or 12' wire harness
- Includes universal mounting kit for dash, deck, suction cup, and mirror mounting

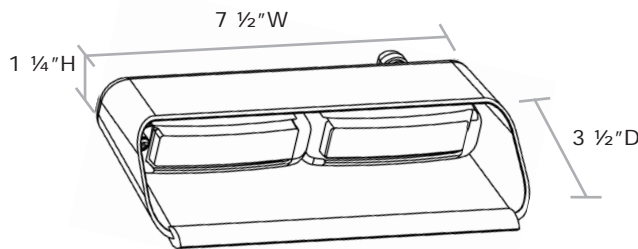

HK2 hood

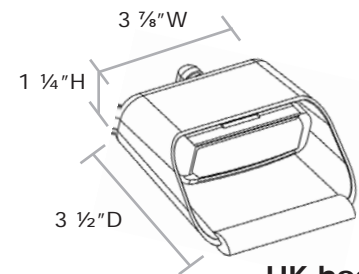

HK hood

Replacement Parts

Black bezel	30019-150B
Chrome bezel	30019-150P
Cig. plug	920-PAT20LO
Single hood	P30019-234
Double hood	P30019-235
Headliner bracket	274-DLX4-6-H
Universal mount kit for single head	274-DLX4-6-HK

Part #	Description	Voltage	Amp Draw★	Weight	Approvals★
DLX4-HK-**	Four LED, single hood kit, cig. plug	10-16V DC	0.3 amps @ 12V DC	< 2 lbs.	SAE Class I A, W
DLX4-HK-1-**	Four LED, single hood kit, hardwire	10-30V DC			
DLX4-HK2-**	Four LED, double hood kit, cig. plug	10-16V DC	0.6 amps @12V DC		SAE Class I A, AB, AR, AW, B, BW, R, RB, RW, W
DLX4-HK2-1-**	Four LED, double hood kit, hardwire	10-30V DC			
DLX6-HK-**	Six LED, single hood kit, cig. plug	10-16V DC	0.5 amps @ 12V DC		California Title 13 A, AB, AR, B, RB, R
DLX6-HK-1-**	Six LED, single hood kit, hardwire	10-30V DC			
DLX6-HK2-**	Six LED, double hood kit, cig. plug	10-16V DC	1 amp @ 12V DC		
DLX6-HK2-1-**	Six LED, double hood kit, hardwire	10-30V DC			

★ Amp draw/Approvals will vary depending on the color of the LEDs and the flash pattern selected

DLX4 Colors



DLX6 Colors



⚠ Warning: Cancer and Reproductive Harm - www.P65Warnings.ca.gov



Toll Free Fax Line: 1-888-478-2797
www.starheadlight.com





DLXTRMC-1



DLXTRMC-4



DLXTRMC-1C



DLXTUMC-1



DLXTUMC-1



DLXTUMC-4

DLXT*MC

- Ultra thin profile only 0.6" thick
- Tri-Color: thirty-six super bright Star LEDs (twelve LEDs per color)
- Twenty different selectable flash patterns
- Auxiliary Stop/Tail/Turn and back-up mode (standard for RAW version, programmable for other colors)
- Built-in ambient light sensor for optional Auto Dim
- Programmable Steady Burn mode for any color(s), Steady Burn functions can be pulse width modulated "PWM" between 85 and 400Hz or flashed without modulation by external flasher
- Current limit protection over entire operating voltage
- Four independent enable lines
- Programmable options include Pattern, Phase, Multi-Color Activation, Steady burn, and Cruise
- Easily programmed with either an Android or iPhone smartphone using our downloadable app or by using the included wires
- S-Link System 2.0™ synchronizing capabilities with other Star LED units
- Flush mount bezel or rubber grommet
- Also available STT approved FMVSS DLTTRMC model

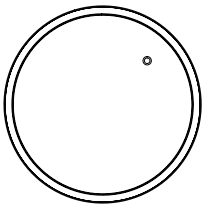

4 11/64" Dia.

DLXTRMC

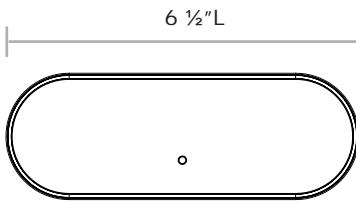
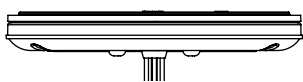

6 1/2" L

2 5/16" H

DLXTUMC

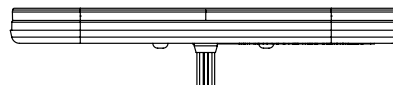

39/64" D

Part #	Description	Voltage	Amp Draw*	Weight	Approvals*
DLXTRMC-1-***	4" Round, Tri-Color thirty-six LED head, Black bezel	9-32V DC	0.3 amps @ 12V DC	< 1 lb.	SAE Class I ABW, RAW, RBW
DLXTRMC-1C-***	4" Round, Tri-Color thirty-six LED head, Chrome bezel				
DLXTRMC-4-***	4" Round, Tri-Color thirty-six LED head, Black grommet				
DLXTUMC-1-***	6" Oval, Tri-Color thirty-six LED head, Black bezel				SAE Class I ABW, RBW, RBA
DLXTUMC-1C-***	6" Oval, Tri-Color thirty-six LED head, Chrome bezel				
DLXTUMC-4-***	6" Oval, Tri-Color thirty-six LED head, Black grommet				
DLTTRMC-1	4" Round, Tri-Color, Stop/Tail/Turn, Warn, Black bezel				SAE Class I AWR
DLTTRMC-4	4" Round, Tri-Color, Stop/Tail/Turn, Warn, rubber grommet				

*Amp draw/Approvals will vary depending on the color of the LEDs and the flash pattern selected

Tri-Colors



Warning: Cancer and Reproductive Harm - www.P65Warnings.ca.gov

Phone Number: 585-226-9500
www.starheadlight.com





Mounting



DLNT-121S

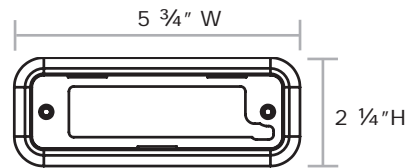

Single Bezel



End

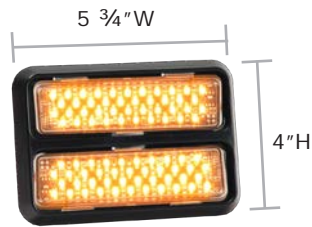

**Double Bezel
DLXT-2CUST**

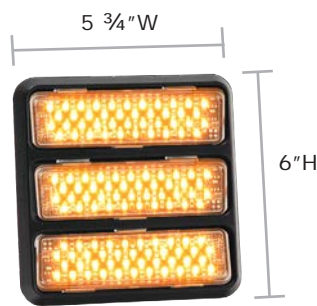

**Triple Bezel
DLXT-3CUST**



DLNT-122SCRW



DLXT-121-WW



DLXT-121CBB



DLXT-124-RR

DLXT

- Ultra-thin LED Auxiliary light
- High intensity LED lights are built with fully encapsulated circuitry
- S-Link System synchronizing capabilities with other Star LED units (DLXT only)
- For interior or exterior applications
- Black (standard), Chrome, or White bezels available
- Optional brackets are available for single bezels
- Reverse polarity protected current limiting protection over the entire operating voltage
- DLXT: Auxiliary warning light, 10 different selectable flash patterns in either of two phases, plus steady-on
- DLHT: Auxiliary Hazard Turn light, flasher in warning pattern overridden by turn signal output, flashes with turn signal input, 10 different selectable flash patterns in either of two phases, plus Steady-On
- DLTT: Auxiliary Stop/Tail/Turn light
- DLNT" Steady burn value head, for use as an auxiliary area light, compartment light, or dummy head
- DLNT-S: Steady burn value head, area or compartment lighting with On/Off switch, for interior mounting only

Part #	Description	Voltage	Amp Draw*	Weight	Approvals*		
DLHT-121-**	Auxiliary hazard turn, rectangle Black bezel	10-16V DC	0.3 amps @ 12V DC	< 1 lbs.	SAE Class II A, R, B		
DLHT-121C**	Auxiliary hazard turn, rectangle Chrome bezel						
DLHT-124-**	Auxiliary hazard turn, oval Black bezel						
DLHT-124C**	Auxiliary hazard turn, oval Chrome bezel						
DLHT-241-**	Auxiliary hazard turn, rectangle Black bezel	24V DC	0.2 amps @ 24V DC		< 1 lbs.	N/A	
DLHT-241C**	Auxiliary hazard turn, rectangle Chrome bezel						
DLHT-244-**	Auxiliary hazard turn, oval Black bezel						
DLHT-244C**	Auxiliary hazard turn, oval Chrome bezel						
DLNT-121-**	Single, Steady burn, Black bezel	10-16V DC	0.3 amps @ 12V DC	< 1 lbs.		N/A	
DLNT-121S-**	Steady burn with switch, Black bezel						
DLNT-121SC-**	Steady burn with switch, Chrome bezel						
DLNT-122S-**	Double-head Steady burn with dual switches, Black bezel	10-16V DC	0.3 amps @ 12V DC			< 1 lbs.	N/A
DLNT-122SC-**	Double head, Steady burn with dual switches Chrome bezel						
DLTT-121-**	Auxiliary Stop/Tail/Turn, rectangle Black bezel	24V DC	0.2 amps @ 24V DC		< 1 lbs.		N/A
DLTT-124-**	Auxiliary Stop/Tail/Turn, oval Black bezel						
DLTT-241-**	Auxiliary Stop/Tail/Turn, rectangle Black bezel						
DLTT-244-**	Auxiliary Stop/Tail/Turn, oval Black bezel						
DLXT-121-**	Auxiliary warning, rectangle Black bezel	10-16V DC	0.3 amps @ 12V DC	< 1 lbs.			SAE Class II A, R, B
DLXT-121C-**	Auxiliary warning, rectangle Chrome bezel						
DLXT-124-**	Auxiliary warning, oval Black bezel						
DLXT-124C-**	Auxiliary warning, oval Chrome bezel	24V DC	0.2 amps @ 24V DC			< 1 lbs.	SAE Class II A, R, B
DLXT-2CUST	Double bezel with two DL*T series lights, indicate LED color and bezel color when ordering						
DLXT-3CUST	Triple bezel with two DL*T series lights, indicate LED color and bezel color when ordering	may vary	may vary		3 lbs.		Reg 10

* Amp draw/Approvals will vary depending on the color of the LEDs and the flash pattern selected. Specific model numbers vary between series and color combinations. Call for details when ordering.

DLXT, DLHT LED Colors



DLTT, DLNT LED Colors



DLNT-S Single Bezel LED colors



DLNT-S Double Bezel LED colors



Toll Free Fax Line: 1-888-478-2797
www.starheadlight.com

Warning: Cancer and Reproductive Harm - www.P65Warnings.ca.gov





274-DLXT-T



274-DLXT-U

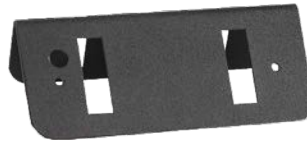

274-DLXT-45



274-DLXT-W



274-DLXT-RL



274-DLXT-2X1



274-DLXT-1X2



BB274-DLXT-LPB



BB274-DLXTHU-LPB

DLXT, DLHT, DLTT Optional Brackets



Oval Bezel

The oval bezels (P30019-133) are designed to allow the DL*T series lights to be mounted in standard 6" oval holes using the #P30199-5 oval rubber grommet

Part #	Description	Weight
274-DLXT-1X2	L-bracket for mounting two single bezel series LED lights horizontally	2 lbs.
274-DLXT-2X1	L-bracket for mounting two single bezel series LED lights vertically	
274-DLXT-45	45° angle mounting bracket	< 1 lb.
274-DLXT-RL	License plate mounting bracket	
274-DLXT-T	Trunk mounting bracket	
274-DLXT-U	L-bracket for universal mounting	
274-DLXT-W	Window mounting bracket	
BB274-DLXTHU-LPB	License plate bracket for vertical mounting of two DLXTHU or DLXT lights	2 lbs.
BB274-DLXT-LPB	License plate bracket for six DLXT lights	

Replacement Bezels and Kits

Single rectangle Black bezel kit with hardware	S30019-132
Single rectangle Chrome bezel kit with hardware	S30019-132P
Single oval Black bezel with hardware kit	S30019-133
Single oval Chrome bezel with hardware kit	S30019-133P
Double Black bezel kit with hardware	S30019-134
Double Chrome bezel kit with hardware	S30019-134P
Triple Black bezel kit with hardware	S30019-135
Triple Chrome bezel kit with hardware	S30019-135P

Warning: Cancer and Reproductive Harm - www.P65Warnings.ca.gov

Phone Number: 585-226-9500
www.starheadlight.com





DLXTHU-4



DLXTHU-1



DLXTHR-4

DLXTH*

- Thirty-six high intensity LEDs
- Twelve customer selectable flash patterns in two phases plus Steady-On
- Circuitry is fully encapsulated within housing and is designed with a breathable membrane pad to reduce condensation
- Over-molded wire seal and strain relief
- S-Link 2.0 System™ synchronizing capabilities with other Star LED units
- Can be mounted just about anywhere, interior or exterior
- Can be mounted in a bezel, grommet, or window mount
- Also available with weatherproof connector
- Split colors available

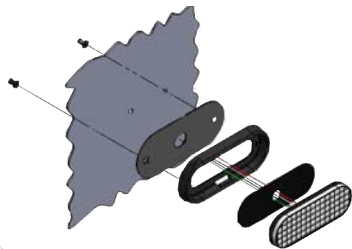

Standard Bezel Mount

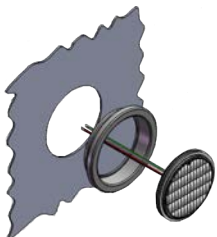

Grommet Mount

Optional Brackets



BKT3904

BKT3920

Replacement Parts for DLXTHR

Round Black bezel	P30019-255
Round Chrome bezel	P30019-255P
Round White bezel	P30019-255W
Round grommet	P30199-7
Round Chrome ring	P30019-99
Round window bezel	S30019-260

Replacement Parts for DLXTHU

Oval Black bezel	P30019-257
Oval Chrome bezel	P30019-257P
Oval White bezel	P30019-257W
Oval grommet	P30199-5
Oval window bezel	S30019-259

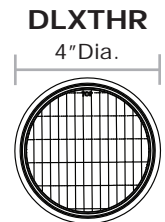
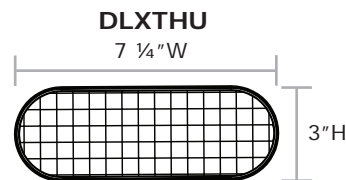
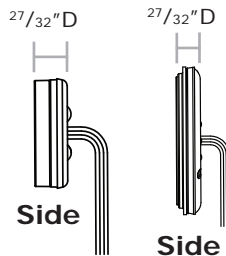

Part #	Description	Voltage	Amp Draw*	Weight	Approvals*
DLXTHR-1.*	4" Round, bezel, flashing	12-24V DC	0.3 amps @12V DC	< 1 lb.	SAE Class I A, R, AW, AB, BC, W
DLXTHR-2.*	4" Round grommet, weatherproof connector, flashing				
DLXTHR-4.*	4" Round, grommet, flashing				
DLXTHR-8.*	4" Round, grommet weatherproof connector, flashing				
DLXTHU-1.*	6" Oval, bezel, flashing				SAE Class I AW
DLXTHU-2.*	6" Oval, weatherproof connector, flashing				
DLXTHU-4.*	6" Oval, grommet, flashing				
DLXTHU-7.*	6" Oval, window bezel, flashing				
DLXTHU-8.*	6" Oval, grommet and connector, flashing				
DLXTHUS-1.**	6" Oval, split color, bezel, flashing				
DLXTHUS-4.**	6" Oval split color, grommet, flashing				

* Amp draw/Approvals will vary depending on the color of the LEDs and the flash pattern selected

DLXTH* Series Color



C = Clear Lens

DLXTHUS Series Colors



Warning: Cancer and Reproductive Harm - www.P65Warnings.ca.gov



Toll Free Fax Line: 1-888-478-2797
www.starheadlight.com





LDH-361



LDH-362



LDH-363



LDH-364

Par 36 LED Lights

- High intensity Star Generation IV LEDs are self contained
- Steady burn or flashing LED heads with built-in flashers
- S-Link System™ synchronizing capabilities with other Star LED units (LDHF models only)
- Twenty customer selectable flash patterns in two phases plus Steady-On (LDHF models only)
- The high efficiency optics are available in three options: Spot, Trapezoidal, and Wide Spread
- Quick installation in any situation
- Patent #D696,035

Part #	Description	Voltage	Amp Draw★	Weight	Approvals★
LDH-361-S*	Sealed beam replacement, steady burn, spot optics	10-30V DC	1.1 amps @ 12V DC	3 lbs.	N/A
LDH-361-T*	Sealed beam replacement, steady burn, trapezoid optics				
LDH-362-E*	Swivel mount, steady burn, wide spread optics				
LDH-362-S*	Swivel mount, steady burn, spot optics				
LDH-362-T*	Swivel mount, steady burn, trapezoidal optics				
LDH-363-E*	Rubber tractor mount, steady burn, wide spread optics				
LDH-363-S*	Rubber tractor mount, steady burn, spot optics				
LDH-363-T*	Rubber tractor mount, steady burn, trapezoidal optics	10-16V DC	4 lb.		
LDH-363M-S*	Rubber tractor mount, steady burn, magnet mount, spot optics				
LDH-363M-T*	Rubber tractor mount, steady burn, magnet mount, trapezoidal optics	10-30V DC	0.6 amps @ 12V DC	3 lbs.	SAE Class I A, R, B, W, RC, BC
LDH-364-E*	Rubber grommet mount, steady burn, wide spread optics				
LDH-364-S*	Rubber grommet mount, spot optics, steady burn				
LDH-364-T*	Rubber grommet mount, trapezoidal optics, steady burn				
LDHF362-E*	Swivel mount, flashing, wide spread optics				
LDHF362-S*	Swivel mount, flashing, spot optics				
LDHF362-T*	Swivel mount, flashing, trapezoidal optics				
LDHF363-E*	Rubber tractor mount, flashing, wide spread optics				
LDHF363-SE*	Rubber tractor mount, flashing, wide spread optics, extended lens				
LDHF363-T*	Rubber tractor mount, flashing, trapezoidal optics				
LDHF364-E*	Rubber grommet mount, flashing, wide spread optics				
LDHF364-T*	Rubber grommet mount, flashing, trapezoidal optics				

LDH-361

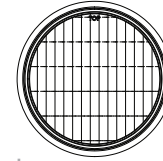

4 13/32" Dia.

Side

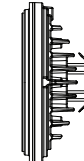

1 31/32" D

LDH-362

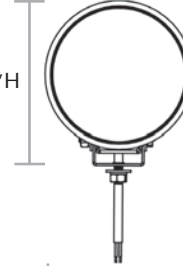

4 29/32" H

4 3/8" Dia.

Side

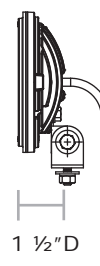

1 1/2" D

LDH-363

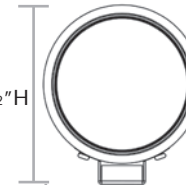

5 13/32" H

4 13/16" Dia.

Side

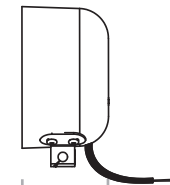

2 29/32" D

LDH-363M

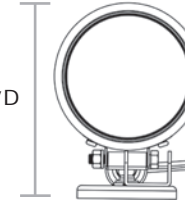

6 3/8" D

4 13/16" Dia.

Side

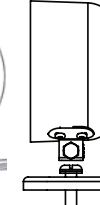

2 29/32" D

LDH-364

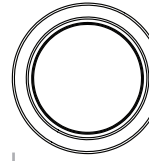

5 1/2" Dia.

Side



1 3/64" D

★ Amp draw/Approvals will vary depending on the color of the LEDs and the flash pattern selected

Steady Burn Colors



Lens Colors



Flashing Colors



White "C" = Clear Lens

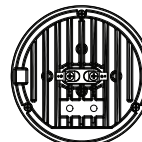

LDH-361

⚠ Warning: Cancer and Reproductive Harm - www.P65Warnings.ca.gov

Phone Number: 585-226-9500

www.starheadlight.com

Replacement Parts

Mounting hardware (LDH-363)	S30017-33
Tractor housing	P30146-16
Swivel mounting bracket	274-LDH-362
Rubber grommet	P30199-7



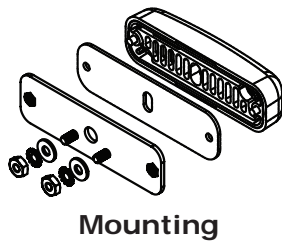
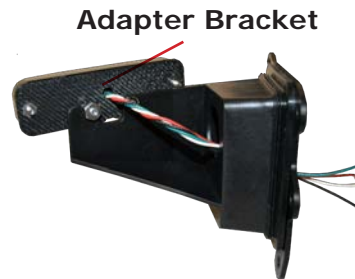
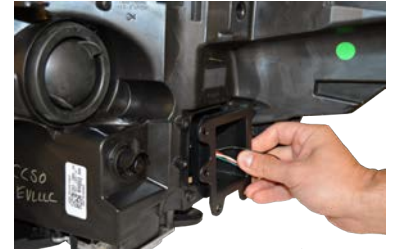
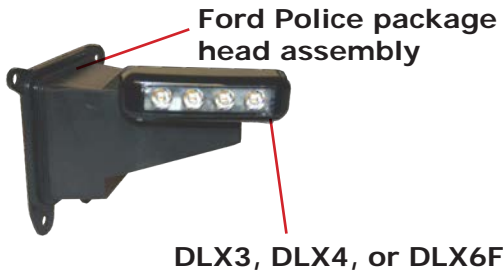

Ford SUV Headlight Bracket

- Integrates directly into the Ford SUV police headlight
- Bracket comes with mounting hardware to mount to Ford housing assembly
- No drilling required
- Compatible with Star Constellation® series (sold separately)

Part #	Description	Weight
BB274-FISUV-DLIT3	Ford SUV bracket, front grille kit, 2015 - 2022 (2022 - compatible - DLIT3 and BKDLIT3 bracket only)	< 1
BB274-FISUV-VER	Bracket for Ford SUV (compatible with DLX3, DLX4, DLX6F series including the Constellation™ series, bracket only)	< 1

Warning: Cancer and Reproductive Harm - www.P65Warnings.ca.gov



Toll Free Fax Line: 1-888-478-2797
www.starheadlight.com





- High intensity Star Generation IV LEDs
- Twelve different selectable flash patterns in either of two phases, plus Steady-On
- Fully encapsulated circuitry within housing for vibration and water protection
- S-Link System™ synchronizing capabilities with other Star Constellation® LED units
- Interior/exterior mount
- Designed for flush or bracket mounting
- Versa Star® optional mounting brackets also available
- Includes 6" cable and connector
- Voltage: BKDLX3, BKDLX3H 10-16V DC
BKDLX4, BKDLX6, BKDLX6F 10-30V DC

BKDLX3 Colors



BKDLX4 Colors



BKDLX6F Colors



BKLDHF311-W-10

- LED hide-a-way heads easily install in 1" mounting holes
- Spherical LED heads are designed with diffusing optics for extremely wide angle light output
- Twelve different selectable flash patterns in either of two phases, plus Steady-On
- Customer changeable colored lenses included in White kit only
- Advanced thermal heat management
- Nickel aluminum housing
- Includes 18" head side cable and 10' cable with connector
- S-Link System™ synchronizing capabilities with other Star Constellation® LED units
- Voltage: 10-30V DC

Lens Colors



LED Colors



BKDLS306

- Omni-directional, mounts in any direction
- Six Star Generation IV LEDs
- Twelve different selectable flash patterns in either of two phases, plus Steady-On
- Fully encapsulated circuitry within housing for vibration and water protection
- S-Link System™ synchronizing capabilities with other Star Constellation® LED units
- Includes 6" cable and connector
- Voltage: 10-30V DC

BKDLS306 Colors

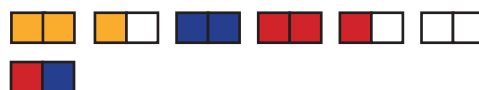

BKDLIT3E



BKDLIT3S



BKDLITE



BKDLITS

- Super bright Star Generation V LEDs
- Twelve different selectable flash patterns in either of two phases, plus Steady-On
- Includes 6" cable and connector
- S-Link System™ synchronizing capabilities with other Star Constellation® LED units
- Voltage: BKDLIT - 10-30V DC
BKDLIT3 - 10-16V DC

BKDLIT3 Colors



BKDLIT Colors



Choose up to 6 LED products (maximum two mini-bars)

Choose the controller BKLD418-2

Choose up to six wiring harnesses

Warning: Cancer and Reproductive Harm - www.P65Warnings.ca.gov

Phone Number: 585-226-9500

www.starheadlight.com





BKDLXTHU



BKDLXTHR

- Six Star Generation IV LEDs
- Twelve different selectable flash patterns in either of two phases, plus Steady-On
- Fully encapsulated circuitry within housing for vibration and water protection
- S-Link System™ synchronizing capabilities with other Star Constellation® LED units
- Interior/exterior mount
- Includes 6" cable and connector
- Voltage: 10-30V DC

BKDLXTHU Colors **BKDLXTHR Colors**



White outline = Clear Lens



BK9016LED

- M-Tech Plus® LED technology that provides a superior 360° warning light image
- Twenty customer selectable flash patterns
- S-Link System™ synchronizing capabilities with other Star Constellation® LED units
- Exterior mount
- Can only use BKSWH-357 cable with this model
- Includes 30" cable and connector
- Voltage: permanent 10-30V DC

Colors



BK9100LED

- Super bright M-Tech Plus® LED technology that provides a superior warning light image
- S-Link System™ synchronizing capabilities with other Star LED units
- Exterior mount
- Includes 30" cable and connector
- Can only use BKSWH-357 cable with this model
- Quad flash only
- Voltage: permanent 10-30V DC

Colors



BK266TSL

BK266TCL

- Star X-Fire® technology
- Twelve different selectable flash patterns in either of two phases, plus Steady-On
- S-Link System™ synchronizing capabilities with other Star Constellation® LED units
- Lightweight polycarbonate, flanged three-hole permanent mount with 1" pipe mount
- Includes 18" cable and connector
- Voltage: permanent mount 9-32V DC

Colors



**Choose up to 6 LED products (maximum two mini-bars)
Choose the controller BKLD418-2
Choose up to six wiring harnesses**

Warning: Cancer and Reproductive Harm - www.P65Warnings.ca.gov



**Toll Free Fax Line: 1-888-478-2797
www.starheadlight.com**



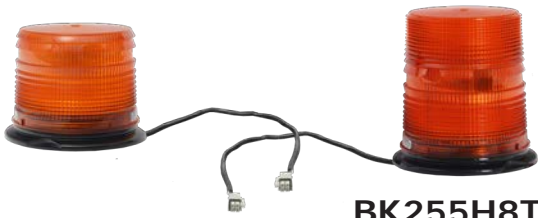

BK255H8TSL

- Eight Star Generation IV LEDs
- Twelve different selectable flash patterns in either of two phases, plus Steady-On
- Fully encapsulated circuitry within housing for vibration and water protection
- S-Link System™ synchronizing capabilities with other Star Constellation® LED units
- Lightweight polycarbonate, flanged three-hole permanent mount with 1" pipe mount
- Includes 18" cable and connector
- Voltage: 10-30V DC

Colors



BK255H8TCL



- BKSWH-346-5 5' cable
- BKSWH-346-10 10' cable
- BKSWH-346-18 18' cable
- BKSWH-346-19 19' cable
- BKSWH-346-24 24' cable



- BKSWH-361-10 10' cable
- BKSWH-361-14 14' cable
- BKSWH-361-16 16' cable
- BKSWH-361-18 18' cable
- BKSWH-361-21 21' cable
- BKSWH-361-23 23' cable
- BKSWH-361-25 25' cable



BKDLXT-121

- High intensity, PLCC4 LEDs
- Fully encapsulated circuitry within housing for vibration and water protection
- S-Link System™ synchronizing capabilities with other Star Constellation® LED units
- Interior or exterior mount
- Ten different selectable flash patterns in either of two phases, plus Steady-On
- Includes 6" cable and connector
- Voltage: 10-16V DC or 24V DC

Colors



- BKSWH-357-18 18' minibar cable
- BKSWH-357-23 23' minibar cable



- BKSWH-361-21FD 21' cable
- BKSWH-361-FD-S 46' cable

BKSWH-361-21FD

High temp cable for Ford SUV



BKSWH-361-FD-S



BKLD418-2

- Connector board for the Star Constellation®
- Pattern select on BKLD418-2 controller does not control patterns within minibars

Choose up to 6 LED products (maximum two mini-bars)
Choose the controller BKLD418-2
Choose up to six wiring harnesses

Warning: Cancer and Reproductive Harm - www.P65Warnings.ca.gov

Phone Number: 585-226-9500
www.starheadlight.com



LDHF301 Series Directional Head



LDHF311 Series Spherical Head



LDHF

- Self-contained, LED flashing circuitry
- Twelve different selectable flash patterns in either of two phases, plus Steady-On
- S-Link System™ synchronizing capabilities with other Star LED units
- Spherical LED heads are designed with diffusing optics for extremely wide angle light
- Optics boost and concentrate light for maximum LED output
- Easily installs in 1" mount holes
- Nickel plated aluminum housings allow for our advanced thermal heat management
- Customer changeable colored lenses (with white kit only), giving these LED lights versatility in the field

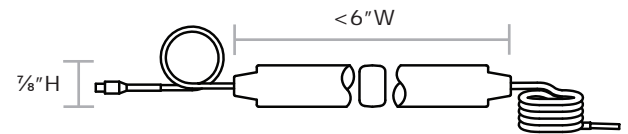
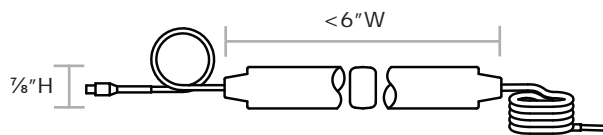
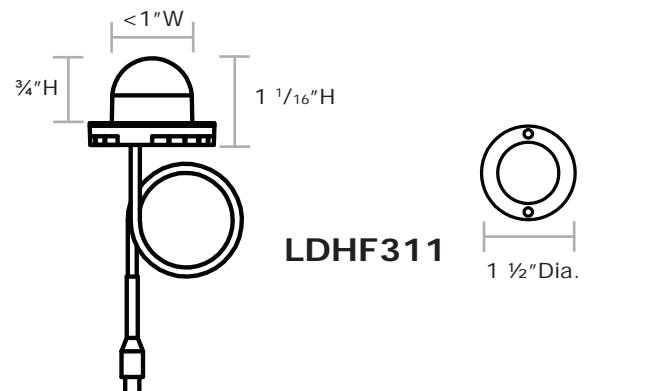
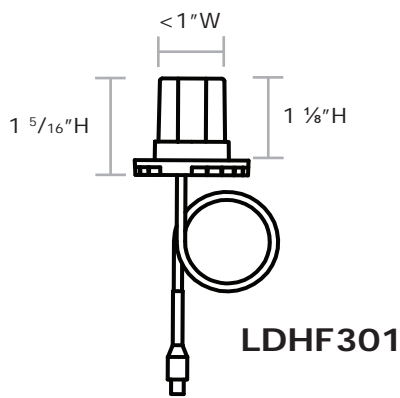

Replacement Parts (* = color)

Replacement head with connector	LDH300C-*
Spherical replacement head with connector	SLDH310C-*
Three color lens kit for spherical heads (A, B, R)	P30129-50K
Single color lens for spherical heads	P30129-50*
Three color lens kit for directional heads (A, B, R)	P30129-47K
Single color lens for directional heads	P30129-47*

Part #	Description	Voltage	Amp Draw*	Weight	Approvals*
LDHF301-*-10	Directional head, 10' cable	10-30V DC	0.6 amps per head	1.5 lbs.	N/A
LDHF301-*-30	Directional head, 30' cable			2.3 lbs.	
LDHF311-*-10	Spherical head, 10' cable			1 lb.	
LDHF311-*-30	Spherical head, 30' cable			3.6 lbs.	

* Amp draw/Approvals will vary depending on the color of the LEDs and the flash pattern selected

Lens Colors



LED Colors



Warning: Cancer and Reproductive Harm - www.P65Warnings.ca.gov



Toll Free Fax Line: 1-888-478-2797
www.starheadlight.com





DLQS-6-RB



DLQS-4



DLQS3-8



DLQS-8-BB

DLQS

- Low Profile LED Traffic Director and Warning Stick
- Weatherproof interior or exterior mount
- Thirty-four customer selectable warning flash patterns plus five phase options
- Self-contained twelve pattern Traffic Director functionality included with six head and 8 head models
- Dual Warn option (eight head model only): Programmable to allow the end heads to flash a warning pattern, while the center six heads flash a Traffic Director pattern
- TD models include the SB44-5 controller
- DLQS-4 comes with a 2' three-wire cable (Power, Ground, Pattern Select)
- DLQS-6 (8) & DLQS3-6 (8) come with a 25' six wire cable, (Power, Ground, Program Wire, Left Enable, Right Enable, Warn Enable, Center Out = Left + Right)
- Bottom and rear T-slots allow for easy mounting via industry standard #10 carriage bolt
- Front load assembly design allows quick and easy swap of heads
- Shipped standard with L-brackets
- Ideal for front push bumpers, rear SUV or pick-up truck windows, headache racks, and running boards



SB44-5

(Included with model numbers ending in TD)

End View

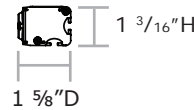

30 ³⁹/₆₄"W



20 1/2"W



25 ³⁹/₆₄"W



19 ¹³/₆₄"W



40 ³⁹/₆₄"W

Part #	Description	Voltage	Amp Draw*	Weight	Approvals*
DLQS3-6-**	20" Six LED heads (3 LEDs in each head), 25' cable	10-16V DC	1.8 amps @ 12V DC	6 lbs.	SAE Class I DLITS only A, B, C, R
DLQS3-6-**-3	20" Six LED heads (3 LEDs in each head), 3' six wire cable			4 lbs.	
DLQS3-8-**	26" Eight LED heads (3 LEDs in each head), 25' cable		2.4 amps @ 12V DC	7 lbs.	
DLQS3-8-**-3	26" Eight LED heads (3 LEDs in each head), 3' cable			6 lbs.	
DLQS-4-**	20.5" Four LED heads (6 LEDs in each head), 2' three-wire cable		1.2 amps @ 12V DC	6 lbs.	
DLQS-6-**	30" Six LED heads (6 LEDs in each head), Traffic Director function, 25' cable		1.8 amps @ 12V DC	10 lbs.	
DLQS-6-AA-TD	30" Six LED heads (6 LEDs in each head), Traffic Director function, SB44-5, 25' cable, Amber			11 lbs.	
DLQS-8-**	40" Eight LED heads (6 LEDs in each head), Traffic Director function, 25' cable		2.4 amps @ 12V DC	12 lbs.	
DLQS-8-AA-TD	40" Eight LED heads (6 LEDs in each head), Traffic Director function, SB44-5, 25' cable, Amber			13 lbs.	
DLQS-47-AA	47", Eight LED heads (6 LEDs in each head), 25' cable, Amber		2.4 amps @ 12V DC	15 lbs.	
DLQS-56-**	56", Six LED heads (6 LEDs in each head), Traffic Director function, 25' cable			15 lbs.	
DLQS-76-**	76", Eight LED heads (6 LEDs in each head), Traffic Director function, 25' cable			18 lbs.	

*Amp draw/Approvals will vary depending on the color of the LEDs and the flash pattern selected

LED Colors



Warning: Cancer and Reproductive Harm - www.P65Warnings.ca.gov

Phone Number: 585-226-9500
www.starheadlight.com



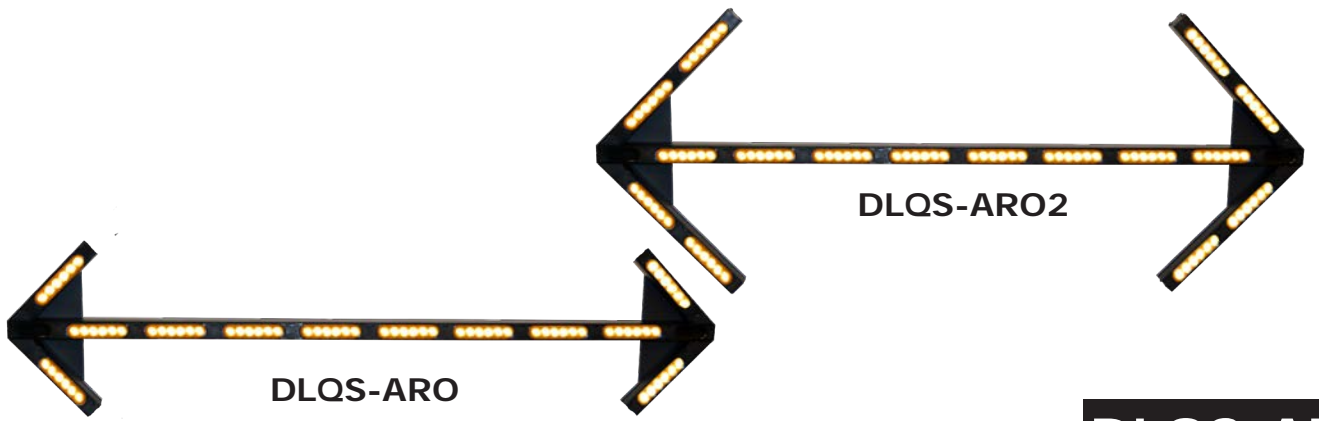

DLQS-ARO

- High-intensity Logic controlled LED Traffic Director with oversized arrowheads
- Weatherproof interior or exterior mount
- Thirty-four customer selectable warning flash patterns plus three options and thirteen head enable options
- Fifteen Traffic Director patterns
- Dual Warn option: allows the end heads to flash a warning pattern, while the center heads flash a Traffic Director pattern
- Includes a 25' 8-conductor cable
- Six function: Right, Left, Center-Out, Full Warn, Arrow tips Warn and Dim
- Bottom and rear T-slots allow for easy mounting via industry standard #10 carriage bolts
- Shipped standard with L-brackets
- Optional SB44-5 keypad controller with feedback

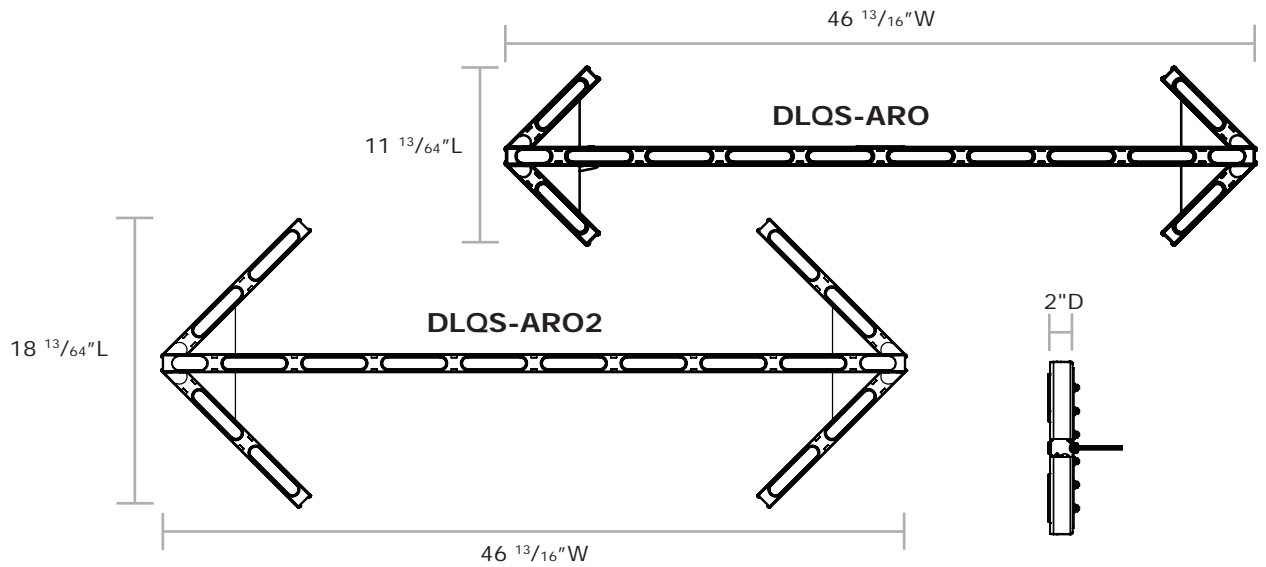

Part #	Description	Voltage	Amp Draw*	Weight	Approvals*
DLQS-ARO-**	47" Arrow stick, twelve head, two head arrow	10 - 16V DC	2.3 amps @ 12V DC	12 lbs.	TBD
DLQS-ARO2-**	47" Arrow stick, sixteen head, four head arrow		3 amps @ 12V DC	14 lbs.	
DLQS-ARO2-AA-TD	47" Arrow stick, sixteen head, four head arrow and SB44-5 key pad controller		3 amps @ 12V DC	15 lbs.	
DLQS-ARO-AA-TD	47" Arrow stick, twelve head, two head arrow and SB44-5 keypad controller		2.3 amps @ 12V DC	13 lbs.	

* Amp draw/Approvals will vary depending on the color of the LEDs and the flash pattern selected

LED Colors



Warning: Cancer and Reproductive Harm - www.P65Warnings.ca.gov



Toll Free Fax Line: 1-888-478-2797
www.starheadlight.com





DLQSMC-ARO



DLQSMC-ARO2

DLQSMC-ARO

- Weatherproof interior or exterior mount
- Forty customer selectable warning flash patterns plus 10 phase options
- Ten Traffic Director patterns
- Dual Warn option: programmable to allow the end heads to flash a warning pattern, while the center heads flash a Traffic Director Pattern
- Enables are programmable for Flashing, Arrow Left, Arrow Right, Work Lights, Cruise, or Single Head Steady (CA T13)
- Includes a 25' eight wire cable, with six input wires (Program wire, Left, Right, Flashing 1, Flashing 2, Steady Burn Tips)
- Front load head assembly design allows quick and easy swap of heads
- Bottoms and rear T-slots allow for easy mounting via industry standard #10 carriage bolt
- Shipped standard with L-brackets
- Optional SB44-5 keypad controller with feedback

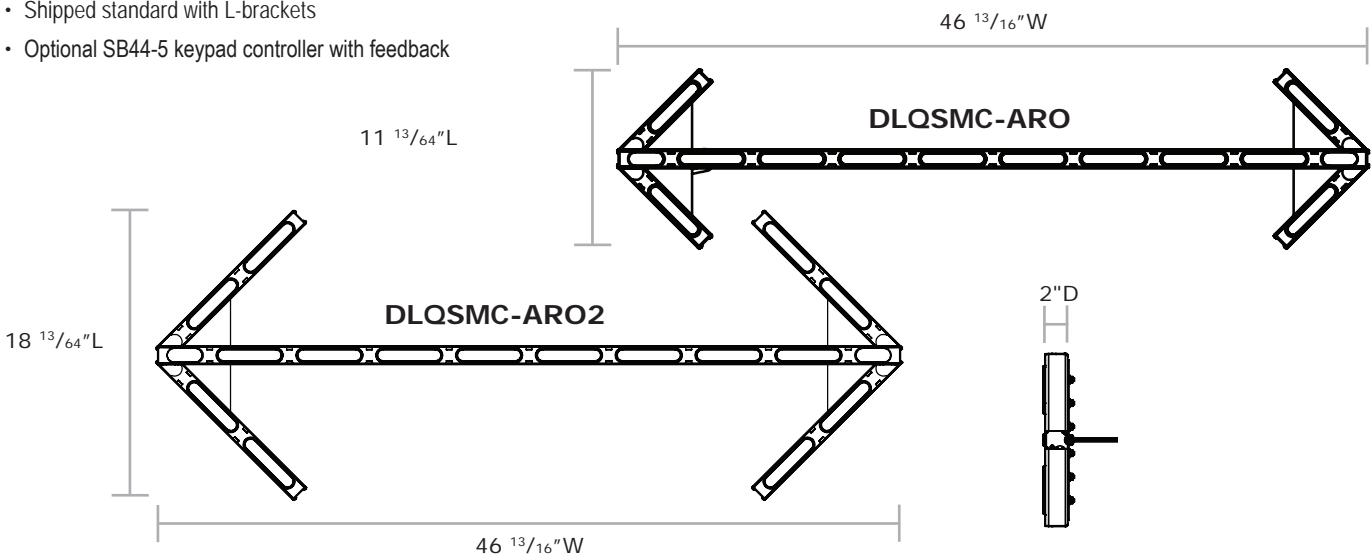

Part #	Description	Voltage	Amp Draw*	Weight	Approvals*
DLQSMC-ARO-CUST	47" Twelve Dual color head DLQSMC arrow stick, with two head arrow	10-16V DC	2.3 amps @ 12V DC	14	TBD
DLQSMC-ARO-CUST-TD	47" Twelve Dual color head DLQSMC arrow stick, with two head arrow and SB44-5 keypad controller			15	
DLQSMC-ARO2-CUST	47" sixteen Dual color head DLQSMC arrow stick, with four head arrow		3 amps @ 12V DC	16	
DLQSMC-ARO2-CUST-TD	47" sixteen Dual color head DLQSMC arrow stick, with four head arrow and SB44-5 keypad controller			17	

* Amp draw/Approvals will vary depending on the color of the LEDs and the flash pattern selected

LED Colors



Warning: Cancer and Reproductive Harm - www.P65Warnings.ca.gov

Phone Number: 585-226-9500
www.starheadlight.com





DLQSMC-4



DLQSMC-6



DLQSMC-8

DLQSMC

- Quickstick Traffic Director with Dual Color heads
- Weatherproof interior or exterior mount
- Thirty-six customer selectable warning flash patterns plus ten phase options and 13 Head Enable options
- Dual Warn option (eight head module only): programmable to allow the end heads to flash a warning pattern, while the center six heads flash a Traffic Director Pattern
- Self-contained ten pattern Traffic Director functionality (standard with six head and eight models, programmable for four head models)
- Includes a 25' 8-conductor harness: six and eight head models (Power, Ground, Warn Color 1, Warn Color 2, Left, Right, Cruise, and Programming), four head models (Power, Ground, Takedowns, Warn Color 1, Warn Color 2, Dual Color Warn, Cruise, and Programming)
- Optional functions for six and eight head models include Center Out, Takedowns, and Dual Color Flash
- Optional functions for four head models include Right, Left, and Center Out
- Bottom and rear T-slots allow for easy mounting via industry standard #10 carriage bolts
- Shipped standard with L-brackets
- Ability to reprogram most Enable wires to any desired function
- Ideal for front push bumpers, rear SUV or pickup truck windows, headache racks, and running boards

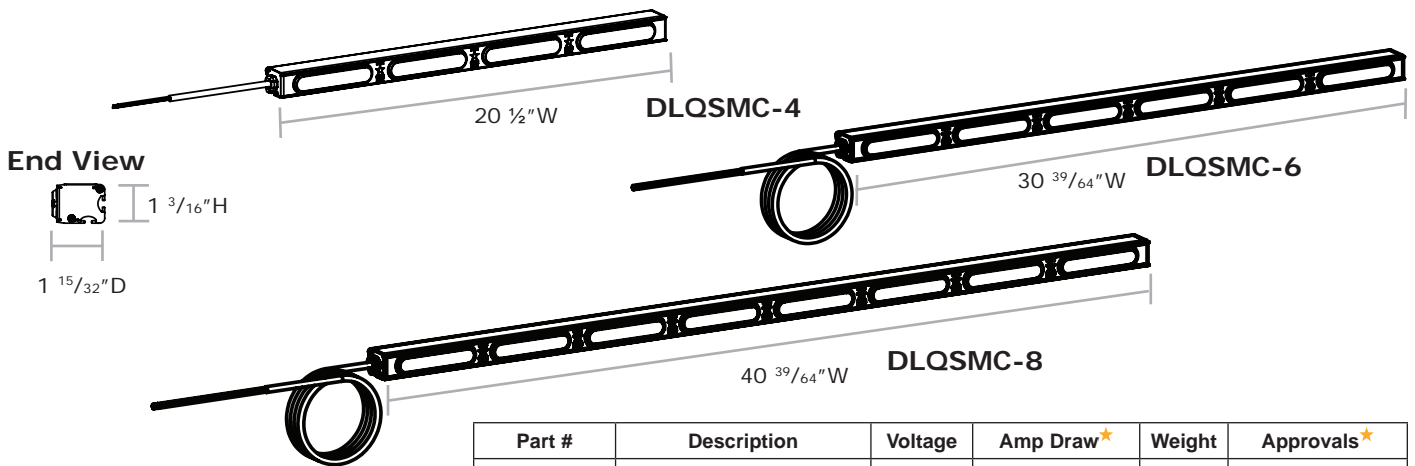

Part #	Description	Voltage	Amp Draw*	Weight	Approvals*
DLQSMC-4-**	Four LED heads, DLITMC heads	10-16V DC	1.5 amps @ 12V DC	7 lbs.	SAE Class I A, B, C, R
DLQSMC-6-**	Six LED heads, DLITMC heads		2.2 amps @ 12V DC	11 lbs.	
DLQSMC-8-**	Eight LED heads, DLITMC heads		2.8 amps @ 12V DC	13 lbs.	

* Amp draw/Approvals will vary depending on the color of the LEDs and the flash pattern selected

LED Colors

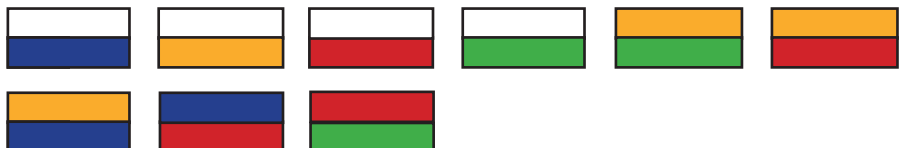

Warning: Cancer and Reproductive Harm - www.P65Warnings.ca.gov



Toll Free Fax Line: 1-888-478-2797
www.starheadlight.com





TCS-1



Reverse side



TCS-2

Stop/Slow LED Traffic Signs

- Signs put traffic control right at your fingertips
- Light sequences bring attention quickly to any situation
- Automatic activation control means you can provide quick response to any need
- Sign turns on when lifted upright
- Sign turns off when lowered
- Operates on three "C" cells (not included)
- Built in flasher
- STOP is in Red LEDs
- SLOW is in Amber LEDs

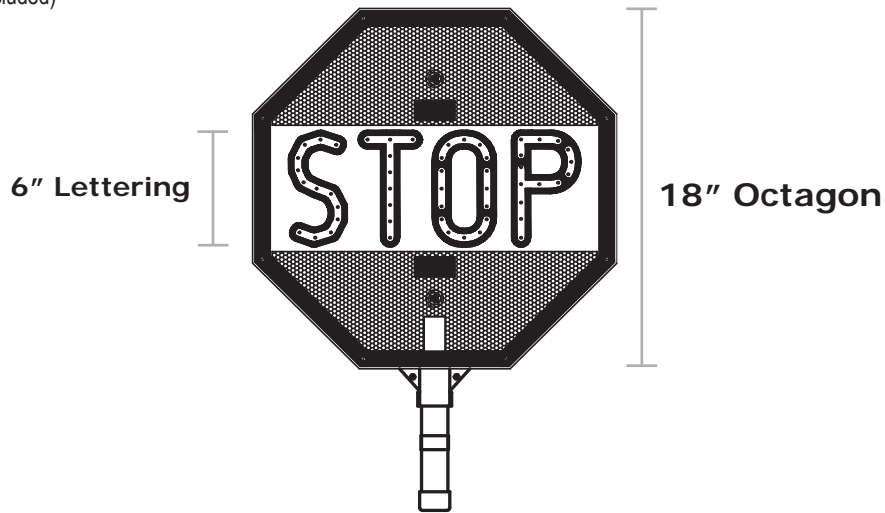

Part #	Description	Weight	Approvals
TCS-1	Slow/Stop traffic control sign (113 LEDs)	2 lbs.	N/A
TCS-1REF	Slow/Stop traffic control sign with M.U.T.C.D. approved reflective tape (113 LEDs)		M.U.T.C.D.
TCS-2	Stop/Stop traffic control sign (104 LEDs)		N/A
TCS-2REF	Stop/Stop traffic control sign with M.U.T.C.D. approved reflective tape (104 LEDs)		M.U.T.C.D.
TCS-6	6' extension pole (not shown)		N/A

Warning: Cancer and Reproductive Harm - www.P65Warnings.ca.gov

Phone Number: 585-226-9500
www.starheadlight.com





ULB34-1

- Low profile rear window LED warning light
- Perfect for unmarked vehicle applications
- For interior applications only
- Six-head, eighteen high intensity, Star Generation IV LEDs
- Thirty-five customer selectable flash patterns
- Housing designed to fit the curve of the vehicle
- Hardwire, 15' length

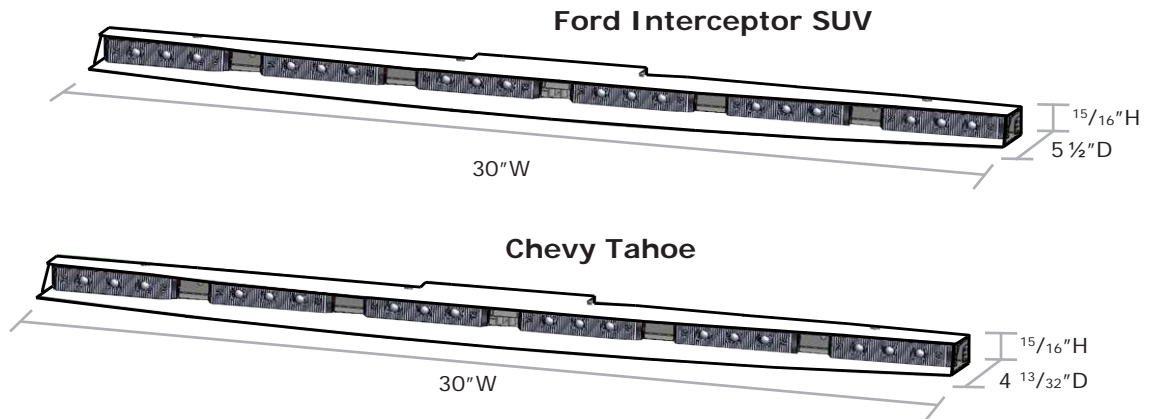

Part #	Description	Voltage	Amp Draw*	Weight	Approvals*
ULB34-1-FISUV-**	Starburst, six head, Ford Interceptor SUV fits '16 - '19	10-16V DC	2.9 amps @ 12V DC	3 lbs.	SAE Class I Photometrics A, R, B
ULB34-1-FISUV20-**	Starburst, six head, Chevy Tahoe/Suburban fits 2020				
ULB34-1-TA21-**	Starburst, six head, Chevy Tahoe/Suburban fits '21 - '22				

* Amp draw/Approvals will vary depending on the color of the LEDs and the flash pattern selected

LED Colors



Warning: Cancer and Reproductive Harm - www.P65Warnings.ca.gov



Toll Free Fax Line: 1-888-478-2797
www.starheadlight.com





ULB38-TD

- Dual-Color interior undercover LED lightbar and Traffic Director
- Lineum X™ technology provides Dual-Color functionality in every head
- Traffic Director bar perfect for undercover or unmarked vehicle applications
- Six-head, seventy-two high intensity, Star Generation IV LEDs
- Thirty-one customer selectable warning flash patterns, five phases, and thirteen head enable settings
- Nine Traffic Director patterns
- Low power dimming feature
- Housing designed to fit the curve of the vehicle
- 12', eight conductor wire harness
- Clone (duplicate settings for a fleet from 1 unit)
- Function wires: Level 1 Warning (Color 1), Level 2 Warning (Color 1), Left, Right, Center-Out (Left + Right), TD Warn, Pattern Select/Dim/Cruise

Ford FISUV20

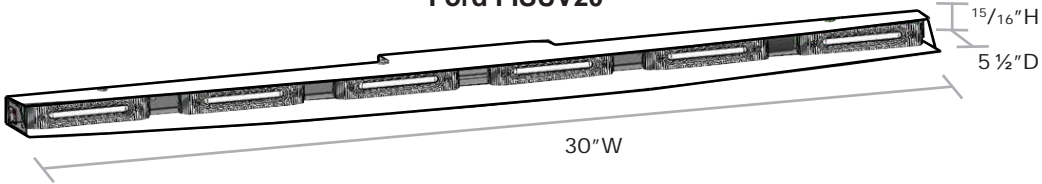

Chevy Tahoe 2021

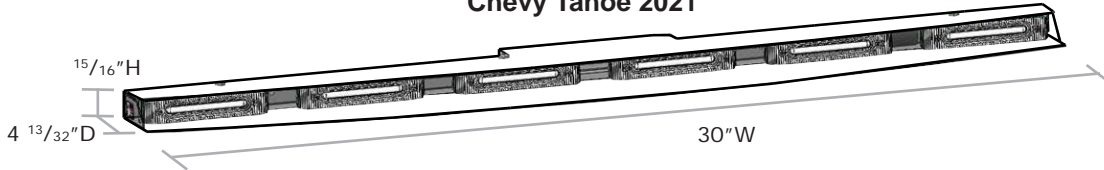

Part #	Description	Voltage	Amp Draw★	Weight	Approvals★
ULB38-TD-FISUV	Lineum, dual-color heads, Ford Interceptor SUV fits '16 - '19	10-16V DC	2.7 amps @ 12V DC	2 lbs.	Exceeds SAE Class I Photometrics A, B
ULB38-TD-FISUV20	Lineum, dual-color heads, Ford Interceptor SUV fits '20 - '22 and Tahoe Suburban '20				
ULB38-TD-TA21	Lineum, dual-color heads, Chevy Tahoe/Suburban SUV fits '20 - '22				

★Amp draw/Approvals will vary depending on the color of the LEDs and the flash pattern selected

Traffic Director Color



Color 1



⚠ Warning: Cancer and Reproductive Harm - www.P65Warnings.ca.gov

Phone Number: 585-226-9500
www.starheadlight.com





ULB48-TD

ULB48-TD

- Dual-Color interior undercover Traffic Director and Warning Light
- Lineum X™ LED technology provides Dual-Color functionality in every head
- One hundred twenty high intensity, Star Generation IV LEDs
- Options to flash outer LEDs with six or eight heads of Traffic Director
- Perfect for undercover or unmarked vehicle applications
- Six inputs/seven functions: Right, Left, Center-Out (Left + Right), Amber Warn (Color 2), Level 1 Flashing (Color 1), Level 2 Flashing (Color 1), Pattern Select Dim/Cruise
- Thirty-one customer selectable warning patterns
- Nine Traffic Director patterns
- Thirteen user programmable Head Enable settings
- Five user programmable Phase settings
- Programmable cycling between warning and Traffic Director patterns
- Clone feature allows you to easily copy the settings from one unit to another (perfect for fleets!)
- Low profile - less than 1" high
- Interior applications only
- Low power dimming feature
- Designed to mount in rear window (but could be used in front window)
- 12', eight conductor wire harness

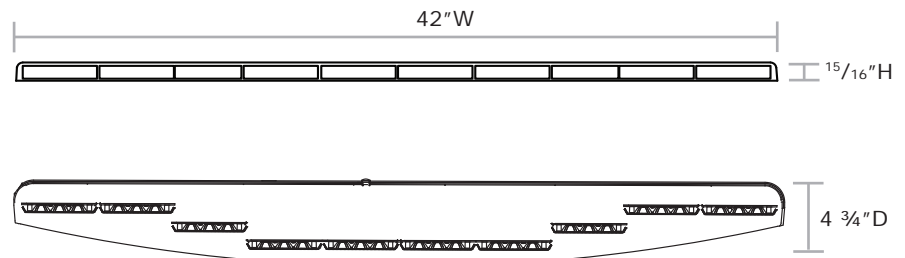

Part #	Description	Voltage	Amp Draw*	Weight	Approvals*
ULB48-TD	Traffic Director	10-16V DC	6.3 amps @ 12V DC	4 lbs.	Class I A, B
274-ULB42BKT	Universal front and rear mount kit (included)		N/A	2 lbs.	N/A

*Amp draw/Approvals will vary depending on the color of the LEDs and the flash pattern selected

Traffic Director (Color 2)



Color 1



Warning: Cancer and Reproductive Harm - www.P65Warnings.ca.gov

Toll Free Fax Line: 1-888-478-2797
www.starheadlight.com





ULB14-BW



ULB24-RB

ULB14, ULB24

- Interior mount LED lightbar is perfect for undercover or unmarked vehicles
- Extremely thin profile
- Thirty-five customer selectable flash patterns
- Thirty second Superburst™ all LED steady burn mode (ULB24 only)
- Designed to mount under the center visor clips above the rear view mirror in minutes
- Includes adjustable baffle to eliminate “flash back” from the window
- ULB24 split design straddles the overhead console
- ULB14 designed for the passenger side mounting
- ULB24 has twenty-four long life, Star Generation IV LEDs
- ULB14 has twelve long life, Star Generation IV LEDs
- No drilling required with vehicle specific visor brackets!
- ULB24-DLP models equipped with two White Takedown/Pursuit heads

ULB24

34" min. - 56" max. W

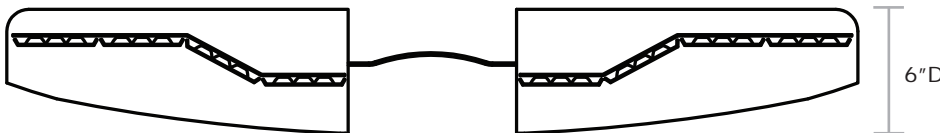
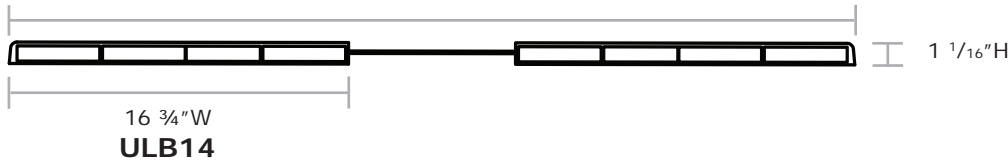

Part #	Description	Voltage	Amp Draw*	Weight	Approvals*
ULB14	Star Half Phantom™	10-16V DC	2 amps @ 12V DC	1.5 lbs.	SAE Class I A, R, W
ULB24	Star Split Phantom™		2.9 amps @ 12V DC	2.8 lbs.	
ULB24-DLP	Star Split Phantom™ with directional LED Takedown/Pursuit lights		2.6 amps @ 12V DC		

*Amp draw/Approvals will vary depending on the color of the LEDs and the flash pattern selected

Replacement Parts for ULB24

- Cig. plug with 12' cord 920-10
- Drivers side baffle S30147-151L
- Passenger side baffle S30147-151R

Replacement Parts for ULB14

- Cig. plug with lighted on/off switch and 12' cord 176-SW
- Passenger side baffle S30147-151R

LED Colors



Warning: Cancer and Reproductive Harm - www.P65Warnings.ca.gov

Phone Number: 585-226-9500
www.starheadlight.com





ULB18-BW



ULB28-RR-BB

ULB18, ULB28

- Extremely thin profile
- Dual-color interior undercover LED lightbar with full Takedown/Pursuit functionality
- Lineum X™ technology
- Dual-Color functionality in every head
- Thirty-one customer selectable flash patterns, five phases, and thirteen head enable options: interior undercover LED lightbar with full takedown/pursuit functionality
- Five Inputs/Functions: Level 1 Flashing, Level 2 Flashing, Pursuit (Flashing White), Takedown (Steady White), California T13 Steady Red, Pattern Select/Dim/Cruise
- Low power dimming feature
- ULB18 has forty-eight high intensity Star Generation IV LEDs
- ULB28 has ninety-six high intensity Star Generation IV LEDs
- Designed to mount in front windshield straddling overhead console
- No drilling required with vehicle specific visor brackets
- Installs in minutes
- 12', eight conductor wire harness

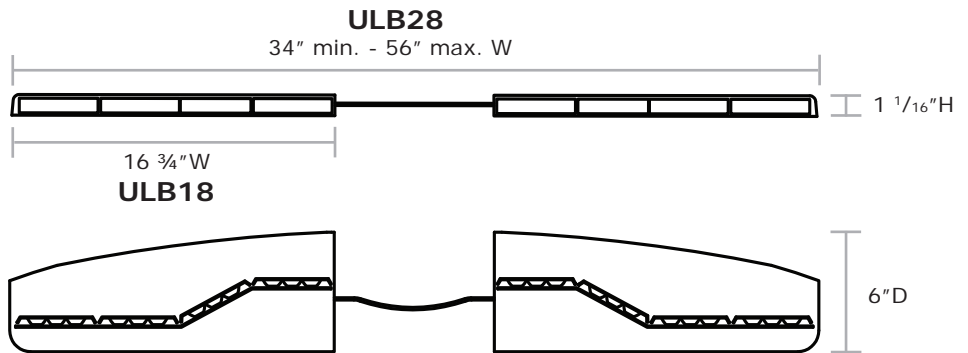

Replacement Parts for ULB18

Bent end baffle	S30147-151-2R
Baffle gasket	P30047-169-18.5

Replacement Parts for ULB28

Bent end baffle left	S30147-151-2L
Bent end baffle right	S30147-151-2R
Baffle gasket (Need 2)	P30047-169-18.5



Part #	Description	Voltage	Amp Draw★	Weight	Approvals★
ULB18	Half Phantom™	10-16V DC	2.4 amps @ 12V DC	1.5 lbs.	SAE Class I California Title 13 ULB28 A, R, B
ULB28	Star Split Phantom™		4.3 amps @ 12V DC	2.8 lbs.	

★ Amp draw/Approvals will vary depending on the color of the LEDs and the flash pattern selected

LED Colors for ULB18 and ULB28



Warning: Cancer and Reproductive Harm - www.P65Warnings.ca.gov



Toll Free Fax Line: 1-888-478-2797
www.starheadlight.com





ULB28-CH, ULB28-FIS, ULB28-FISUV

- Extremely thin profile
- Dual-color interior undercover LED lightbar with full Takedown/Pursuit functionality
- Lineum X™ technology
- Dual-Color functionality in every head
- Thirty-one customer selectable flash patterns, five phases, and thirteen head enable options: interior undercover LED lightbar with full takedown/pursuit functionality
- Five Inputs/Functions: Level 1 Flashing, Level 2 Flashing, Pursuit (Flashing White), Takedown (Steady White), California T13 Steady Red, Pattern Select/Dim/Cruise
- Vehicle specific models designed to conform to the windshield and headliner

32 1/2" min. - 53 1/2" max. W

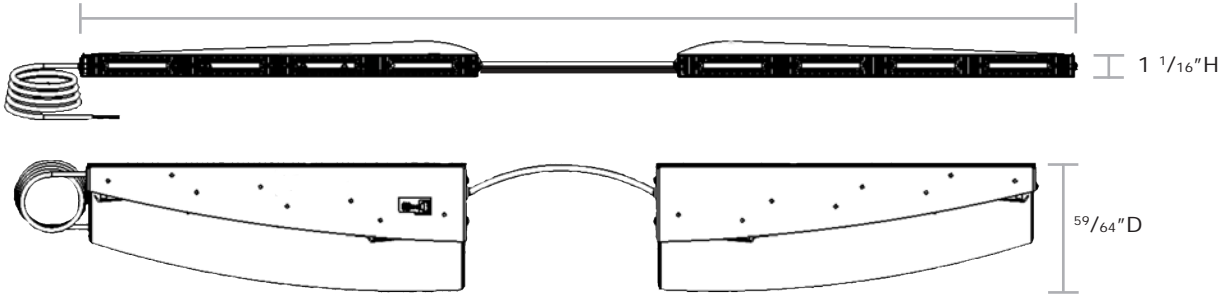

Replacement Parts for ULB28-CH

Gasket	P30047-173-16
Driver side Dodge Charger bracket	P30150-431DP
Passenger side Dodge Charger bracket	P30150-431PP

Replacement Parts for ULB28-FIS

Gasket	P30047-173-16
Driver side Ford Interceptor sedan bracket	P30150-420DP
Passenger side Ford Interceptor sedan bracket	P30150-420PP

Replacement Parts for ULB28-FISUV

Driver side Ford Interceptor SUV bracket	P30150-424DP
Passenger side Ford Interceptor SUV bracket	P30150-424PP

Part #	Description	Voltage	Amp Draw★	Weight	Approvals★
ULB28-CH	Split Phantom™, 2015 - 2021 Dodge Charger	10-16V DC	4.3 amps @ 12V DC	1.5 lbs.	SAE Class I A, B
ULB28-FIS	Split Phantom™, 2012 - 2019 Ford Interceptor Sedan				
ULB28-FISUV	Split Phantom™, 2012 - 2022 Ford Interceptor SUV				

★Amp draw/Approvals will vary depending on the color of the LEDs and the flash pattern selected

LED Colors for ULB28



⚠ Warning: Cancer and Reproductive Harm - www.P65Warnings.ca.gov

Phone Number: 585-226-9500
www.starheadlight.com



Vehicle Specific Phantom Brackets

Model	Make	Beginning Year	Through Year	ULB14 and ULB18 Half Phantom Bracket Model Number	ULB24 and ULB28 Full Split Phantom Bracket Model Number
Caprice	Chevrolet	2011	2017	274-ULB10-CP	274-ULB21-CP
Tahoe		2007	2020	274-ULB10-TA	274-ULB21-TA
Tahoe			2022		274-ULB21-TA21
Suburban		2007	2020	274-ULB10-TA	274-ULB21-TA
Silverado		2014	2020		274-ULB21-U1
Universal				274-ULB10-U	274-ULB21-U
Charger	Dodge	2011	2022	274-ULB10-CH11	274-ULB21-CH11
Durango		2010	2022	274-ULB10-DU	274-ULB21-DU
Ram		2009	2019	274-ULB10-RM	274-ULB21-RM
Ram Pick-Up 1500		2020	2022		274-ULB21-RM20
Universal				274-ULB10-U	274-ULB21-U
Explorer	Ford	2006	2019	274-ULB10-EX	274-ULB21-EX
Explorer		2020	2022		274-ULB21-EX20
Expedition		2007	2020	274-ULB10-EX	274-ULB21-EX
Expedition		2020	2022	274-ULB21-EPD20	
F-150		2004	2014	274-ULB10-EX	274-ULB21-EX
F-150		2015	2022	274-ULB10-F1	274-ULB21-F1
Interceptor Sedan		2012	2022	274-ULB10-INT	274-ULB21-INT
Interceptor SUV		2020	2022	274-ULB10-EX	274-ULB21-EX
Universal				274-ULB10-U	274-ULB21-U1

 **Warning:** Cancer and Reproductive Harm - www.P65Warnings.ca.gov



Toll Free Fax Line: 1-888-478-2797
www.starheadlight.com





9900LED

- The smallest minibar Star offers
- Four bright Lineum LED heads give you 360° coverage
- Twenty customer selectable flash patterns in two phases plus Steady-On
- S-Link 2.0 System™ synchronizing capabilities with other Star LED units
- Permanent mount, single bolt mount, or vacuum magnet mount with cig. plug (On/Off and Pattern Select switches)

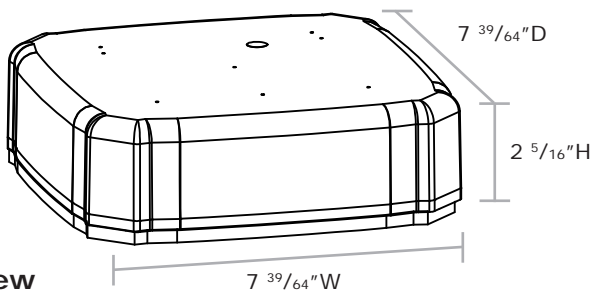

Bottom view of the base

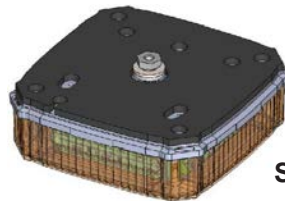
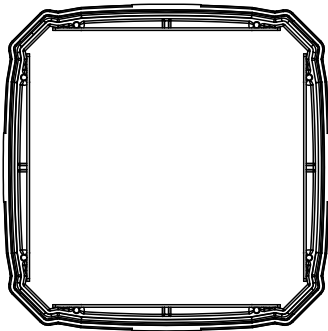

Single bolt mount (9900LEDB)



4 hole mount with expansion nuts (9900LED)

Part #	Description	Voltage	Amp Draw*	Weight	Approvals*
9900LED-*	Star Equalizer LED minibar, permanent mount	10-16V DC	2.3 amps @ 12V DC	4 lbs.	SAE Class I A California Title 13 Compliant
9900LEDB-*	Star Equalizer LED minibar, single bolt mount			5 lbs.	
9900LEDV-*	Star Equalizer LED minibar, vacuum magnet mount			7 lbs.	

* Amp draw/Approvals will vary depending on the color of the LEDs and the flash pattern selected

LED Colors



Dome Colors



Replacement Parts

Gasket	P30047-191
Dome	P30129-91*
Mounting kit	S278-4
Vacuum magnet	P920-16V
Cig. plug	920-PAT18HI-EDGE

Warning: Cancer and Reproductive Harm - www.P65Warnings.ca.gov

Phone Number: 585-226-9500
www.starheadlight.com





9901LED



Worklight not included

- The smallest minibar Star offers
- Four bright Lineum LED heads give you 360° coverage
- Comes with internal hex nuts for easy installation of your worklight, three or four hole configuration
- Compatible most other worklights with identical mounting patterns
- Twelve customer selectable flash patterns in two phases plus steady-on
- S-Link 2.0 System™ synchronizing capabilities with other Star LED units
- Permanent mount only

Bottom View of Base

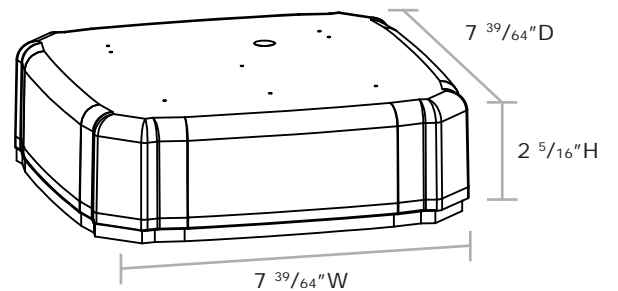
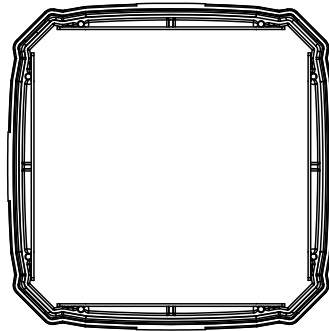

Replacement Parts

Gasket	P30047-191
Dome	P30129-91*
Mounting kit	S278-7

Part #	Description	Voltage	Amp Draw*	Weight	Approvals*
9901LED	Star Equalizer LED minibar, internal hex nuts for worklights, permanent mount	10-16V DC	2.3 amps @ 12V DC	4 lbs.	SAE Class I A California Title 13 Compliant

*Amp draw/Approvals will vary depending on the color of the LEDs and the flash pattern selected

LED Colors



Dome Colors



Warning: Cancer and Reproductive Harm - www.P65Warnings.ca.gov



Toll Free Fax Line: 1-888-478-2797
www.starheadlight.com





9018LED

- Ultra bright, heavy duty Star Lineum LED minibar
- Star Lineum™ LED technology utilizing Star Generation IV high-power LEDs
- Dual-Color version (9018DLED) allows you to “go from Amber to Blue with a flip of a switch”
- Dual-Color: one hundred forty-four Star Generation IV high power LEDs
- Dual-Color: thirty-seven LED customer selectable flash patterns
- Single Color: thirty-six Star Generation IV high power LEDs
- Single color: thirty-five customer selectable flash patterns via pattern select wire
- Conformal coated circuitry protects against shock and vibration
- Full gasketing between the durable polycarbonate domes and the rugged, one-piece, extruded, anodized aluminum base protects against moisture
- Magnet mount versions include a 12' cord and cig. plug with lighted On/Off and Pattern Select switches

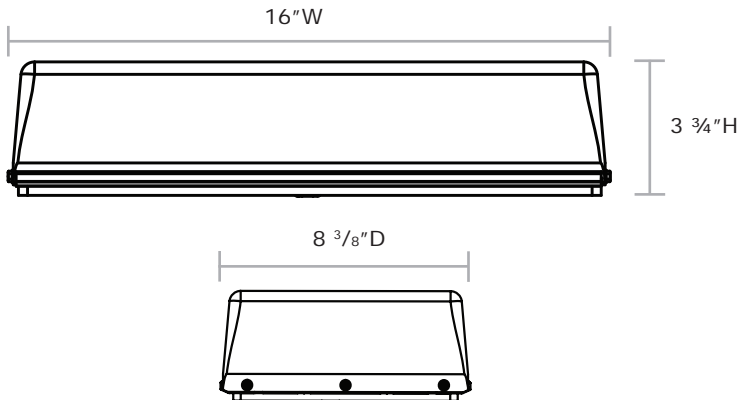

Part #	Description	Voltage	Amp Draw*	Weight	Approvals*
9018DLED-*	Star Omega™, two levels of Dual-Color Lineum LED arrays, Dual-Function, permanent mount	10-16V DC	8 amps @ 12V DC	5 lbs.	SAE Class I A/B
9018LED-*	Star Omega™, single level of single-color, Lineum LED arrays, permanent mount		2.5 amps @ 12V DC	8 lbs.	SAE Class I A
9018LEDV-*	Star Omega™, single level of single color, Lineum LED arrays, vacuum magnet mount, cig. plug		8 amps @ 12V DC		
9018LED9-A	Star Omega™, single level of Super Lineum LED arrays, permanent mount, Amber				

* Amp draw/Approvals will vary depending on the color of the LEDs and the flash pattern selected

LED Colors



Dome Colors



Dual-Color Dome



Configuration Examples

Phase 1 Phase 2

9018LED

- Single color six LED Lineum arrays only
- Single level of arrays
- Flashing alternates between Left/Right sides of minibar
- Single enable wire only

9018LED9

- Amber nine LED super Lineum arrays only
- Single level of arrays
- Flashing alternates between Left/Right sides of minibar
- Single enable wire only



9018DLED

- Dual-Color twelve LED arrays
- Two levels of arrays
- Flashing alternates between left/right sides of minibar
- Dual-Function: two enable wires allow for independent color activation

Replacement Parts (* = color)

Dome 910-316-*

Dome gasket 30047-64

Warning: Cancer and Reproductive Harm - www.P65Warnings.ca.gov

Phone Number: 585-226-9500
www.starheadlight.com





9100LEDV-B

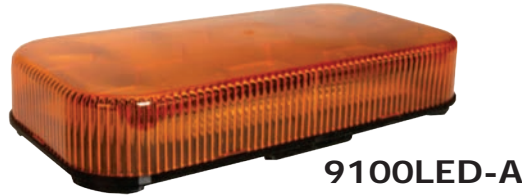

9100LED-A



9100LED-C

9100LED

Mounting

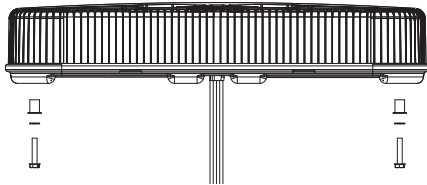

Base

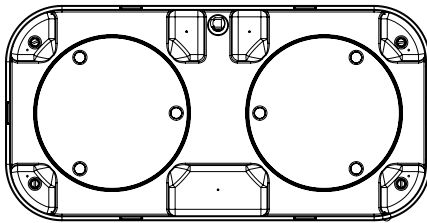

- The Star Contour® is an extremely low profile minibar, made to "contour fit" to the roof of your vehicle
- Super bright M-Tech Plus® LED technology
- Provides a superior warning light image
- Injection molded polycarbonate base is combined with two rubber coated vacuum magnets to "custom mount to your vehicle" (vacuum magnet model)
- Permanent mount - twenty customer selectable flash patterns via external pattern select wire, Dim wire, S-Link System™ synchronizing capabilities with other Star LED units
- Magnet and Vacuum magnet mount - twenty customer selectable flash patterns, 12' cig. plug with lighted On/Off and Pattern Select switches

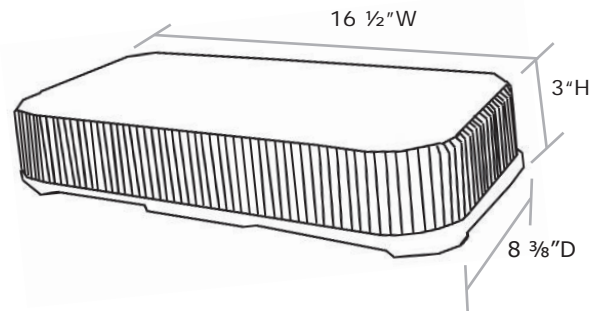

Replacement Parts (* = color)

Dome	910-3-*
Cig. plug	920-PAT18HI
Magnet mount kit	910-177K
Vacuum magnet mount	920-16V
Dome gasket	S30047-64-48

Part #	Description	Voltage	Amp Draw*	Weight	Approvals*
9100LED-*	Star Contour®, permanent mount	10-30V DC	1.5 amps @ 12V DC	4 lbs.	SAE Class I A, W, B California Title 13 available upon request
9100LEDM-*	Star Contour®, magnet mount, cig. plug	10-16V DC		9 lbs.	
9100LEDV-*	Star Contour®, vacuum magnet mount, cig plug			10 lbs.	

*Amp draw/Approvals will vary depending on the color of the LEDs and the flash pattern selected

LED Colors



Dome Colors



Warning: Cancer and Reproductive Harm - www.P65Warnings.ca.gov



Toll Free Fax Line: 1-888-478-2797
www.starheadlight.com





9100LEDV



9100LED

9100LED

- Dual-Color minibar
- Star Contour® is extremely low profile, made to “contour fit” to the roof of your vehicle
- Super bright M-Tech Plus® LED technology
- Each color provides a full 360° warning coverage
- Provides a superior warning light image
- Injection molded polycarbonate base is combined with two rubber coated vacuum magnets to “custom mount to your vehicle” (vacuum magnet model)
- Permanent mount versions - Dual Power wires (one for each color), Pattern Select wire (35 patterns), Dim wire, S-Link synchronization
- Magnet and Vacuum magnet mount - 12' cord and cig. plug with Dual power switches, (one for each color), alternating Triple Flash pattern only

Mounting

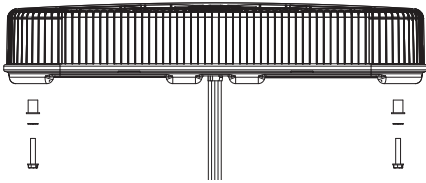

Base

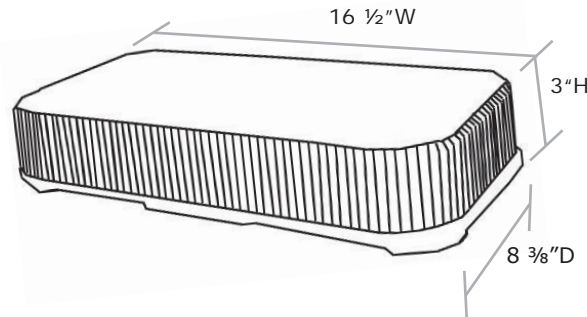
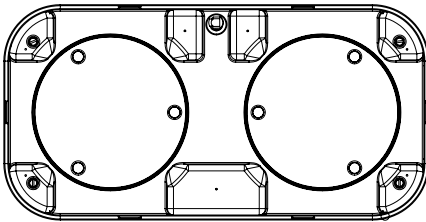

Part #	Description	Voltage	Amp Draw*	Weight	Approvals*
9100LED-*	Star Contour®, permanent mount	10-16V DC	2.3 amps @ 12V DC	4 lbs.	SAE Class I A/B, A/W
9100LEDM-*	Star Contour®, magnet mount, cig. plug			9 lbs.	
9100LEDV-*	Star Contour®, vacuum magnet mount, cig. plug			10 lbs.	

Replacement Parts (* = color)

Dome	910-3-*
Cig. plug	920-2PRW18
Magnet mount kit	910-177K
Vacuum magnet mount	920-16V
Dome gasket	S30047-64-48

* Amp draw/Approvals will vary depending on the color of the LEDs and the flash pattern selected

LED Colors



Dome Colors



Warning: Cancer and Reproductive Harm - www.P65Warnings.ca.gov

Phone Number: 585-226-9500
www.starheadlight.com





9016LEDV-C



9016LED-A



9016LEDM-C

9016LED



- M-Tech Plus® LED technology that provides a superior 360° warning light image
- Twenty customer selectable flash patterns
- S-Link System™ synchronizing capabilities with other Star LED units (hardwire version only)
- Conformal coated circuitry protects against shock and vibration
- Heavy duty minibar with an extruded aluminum base

Base

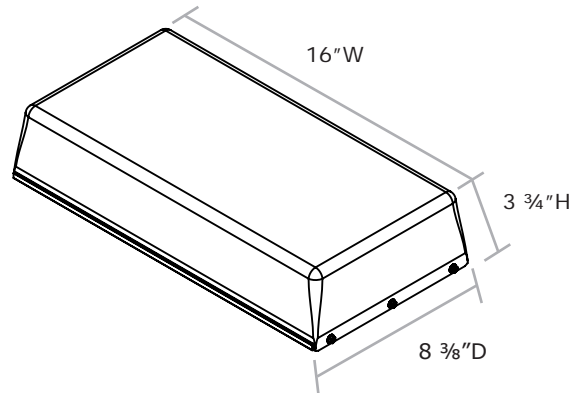
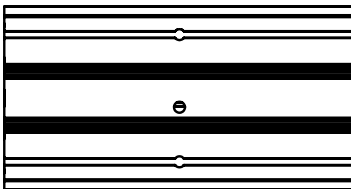

Replacement Parts (* = color)

Dome	910-316-*
Cig. plug	920-PAT18HI
Magnet mount kit	910-177K
Mounting gasket	920-17-16
Vacuum magnet mount kit	920-16V-BK
Dome gasket	30047-64

Part #	Description	Voltage	Amp Draw★	Weight	Approvals★
9016LED-*	Permanent mount	10-30V DC	1.3 amps @ 12V DC	7 lbs.	SAE Class I A, B, R, W California Title 13 available upon request
9016LEDM-*	Magnet mount, cig. plug	10-16V DC		9 lbs.	SAE Class I A, B, R, W
9016LEDV-*	Vacuum magnet mount, cig plug			10 lbs.	California Title 13 available upon request

★Amp draw/Approvals will vary depending on the color of the LEDs and the flash pattern selected

LED Colors

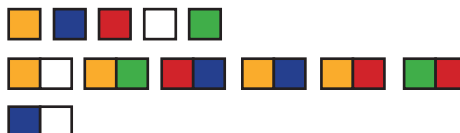

Dome Colors



⚠ Warning: Cancer and Reproductive Harm - www.P65Warnings.ca.gov



Toll Free Fax Line: 1-888-478-2797
www.starheadlight.com





7100LED

- Super heavy duty ultra-bright minibar
- Star Lineum™ LED technology
- 7100DLED - Dual-Color available “go from Amber to Blue with a flip of a switch”
- Single color, thirty-six Star Generation IV high power LEDs
- Single and TB color - thirty-five customer selectable flash patterns via pattern select wire
- Dual-Color, one hundred forty-four Star Generation IV high power LEDs
- Dual-Color - thirty-seven customer selectable flash patterns via pattern select wire
- TB version has seventy-two single color Star Generation IV High Power LEDs
- Available in permanent mount only
- Durable polycarbonate, injection molded domes are fully gasketed to protect against moisture
- Extruded aluminum top and bottom

Configuration Options



7100LED

- Single level of single-color LED arrays
- One power wire activates all heads
- Alternating Left/Right or Simultaneous flashing



7100LED-TB

- Dual-level of single-color LED arrays
- One power wire activates all heads
- Alternating Top/Bottom or Simultaneous flashing

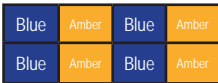

7100DLED

- Dual-level of Dual-Color LED arrays
- Dual-Function: Two power wires (one for each color)
- Alternating Left/Right or Simultaneous flashing

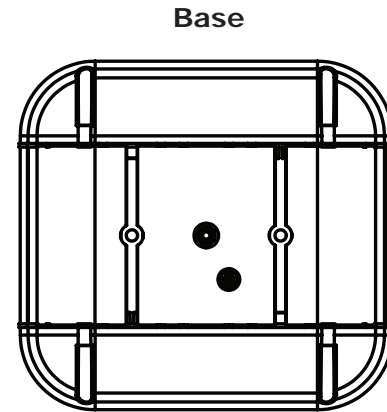
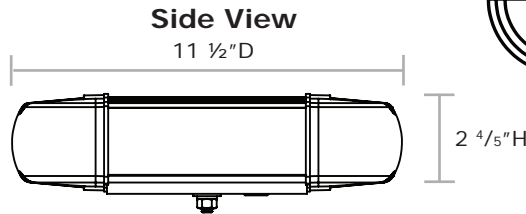
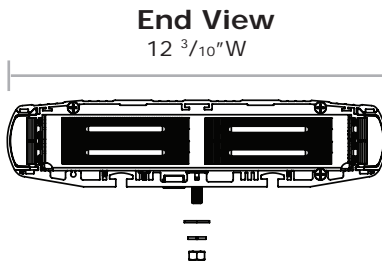

Part #	Description	Voltage	Amp Draw*	Weight	Approvals*
7100LED-*	Left/Right halves are not independently enabled	10-16V DC	2.4 amps @ 12V DC	7 lbs.	SAE Class I A, W
7100DLED-*	Dual-color and dual function				
7100LED-TB-*	Top/Bottom are not independently enabled				

Replacement Parts (* = color)

End dome	720-23-*
Short side dome	720-21S-*
End dome gasket	30047-101
Extrusion gasket	30047-104
End cap screws	30054-8

* Amp draw/Approvals will vary depending on the color of the LEDs and the flash pattern selected

LED Colors



Dome Colors



Warning: Cancer and Reproductive Harm - www.P65Warnings.ca.gov

Phone Number: 585-226-9500
www.starheadlight.com





9202LV-A



9202LV-R



9202LV-B

9202L

- Economical minibar utilizing Star Generation IV LEDs
- Seventeen different selectable flash patterns in either of two phases, plus Steady-On
- Industrial grade virgin polycarbonate lens
- Fully gasketed between the durable polycarbonate dome and base
- Magnet and vacuum magnet mount versions includes 12' cord and cig. plug with On/Off and Pattern Select Switches

Mounting

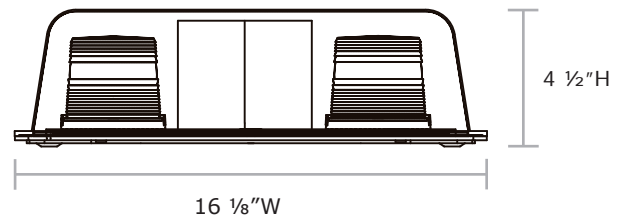
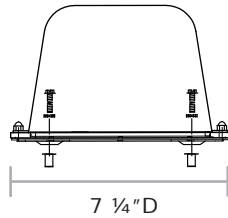

Base

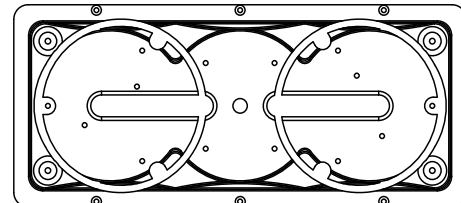

Replacement Parts (* = color)

Outer dome	920-3-*
Inner Fresnel lens	333-*
V-mirrors	820-29
Cig. plug	920-PAT20LO
Magnet (one)	920-16
Magnet kit (four)	920-16-4K
Vacuum magnet	920-16V

Part #	Description	Voltage	Amp Draw*	Weight	Approvals*
9202L-*	Permanent mount	10-30V DC	0.7 amps @ 12V DC	4 lbs.	SAE Class II A
9202LM-*	Magnet mount, cig. plug	10-16V DC		5 lbs.	
9202LV-*	Vacuum magnet mount, cig. plug			6 lbs.	

*Amp draw/Approvals will vary depending on the color of the LEDs and the flash pattern selected

Inner Lens Colors



Dome Colors



Warning: Cancer and Reproductive Harm - www.P65Warnings.ca.gov



Toll Free Fax Line: 1-888-478-2797
www.starheadlight.com





9200LX



9200LXM



9200LXV

9200LX

- Economical ultra-bright minibar utilizing Star X-Fire® technology
- Twelve different selectable flash patterns in either of two phases, plus Steady-On
- Extremely low current draw
- Fully gasketed between the durable polycarbonate dome and base
- Two internal V-mirrors enhance flashes
- Magnet mounts include vinyl pads to avoid scratching the surface
- Permanent mount - selectable flash patterns via external pattern select wire, 24" leads
- Magnet and vacuum magnet mount versions includes 12' cord and cig. plug with On/Off and Pattern Select Switches

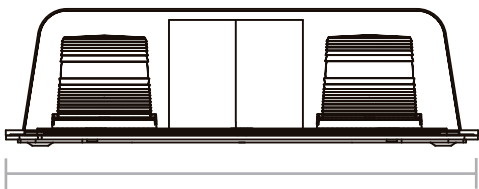

16 1/8" W

4 1/2" H

Mounting

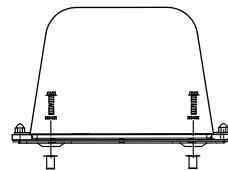

7 1/4" D

Base

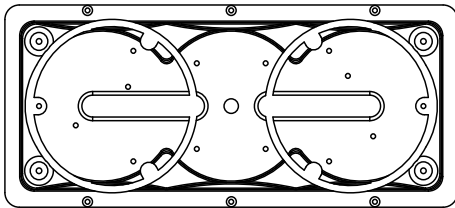

Part #	Description	Voltage	Amp Draw*	Weight	Approvals*
9200LX-*	Permanent mount	10-30V DC	0.7 amps @ 12V DC	4 lbs.	SAE Class I California Title 13 A
9200LXM-*	Magnet mount, cig. plug	10-16V DC		5 lbs.	
9200LXV-*	Vacuum magnet mount, cig. plug				

* Amp draw/Approvals will vary depending on the color of the LEDs and the flash pattern selected

Replacement Parts (* = color)

Outer dome	920-3-*
Inner Fresnel lens	333-*
V-mirrors	820-29
Cig. plug	920-PAT20LO
Magnet (one)	920-16
Magnet kit (four)	920-16-4K
Vacuum magnet	920-16V

Inner Lens Colors



Dome Colors



Warning: Cancer and Reproductive Harm - www.P65Warnings.ca.gov

Phone Number: 585-226-9500
www.starheadlight.com





9200HL-A



9200HLV-B

9200HL

- Economical high-intensity minibar utilizing Star Halo® LED technology is patented (#5,662,702)
- Thirteen customer selectable flash patterns, including Steady-On and 2 Rotating Patterns
- S-Link System™ synchronizing capabilities with other Star LED units (permanent mount only)
- Fully encapsulated circuitry for increased weather and shock resistance
- Fully gasketed between the durable polycarbonate dome and base for protection against environmental contaminants
- Two internal V-mirrors enhance flashes
- Permanent mount - selectable flash patterns via external pattern select wire, 24" leads
- Magnet mounts include vinyl pads to avoid scratching surfaces
- Magnet and Vacuum magnet mount - versions includes 12' cord and cig. plug with On/Off and Pattern Select Switch
- Extremely low current draw

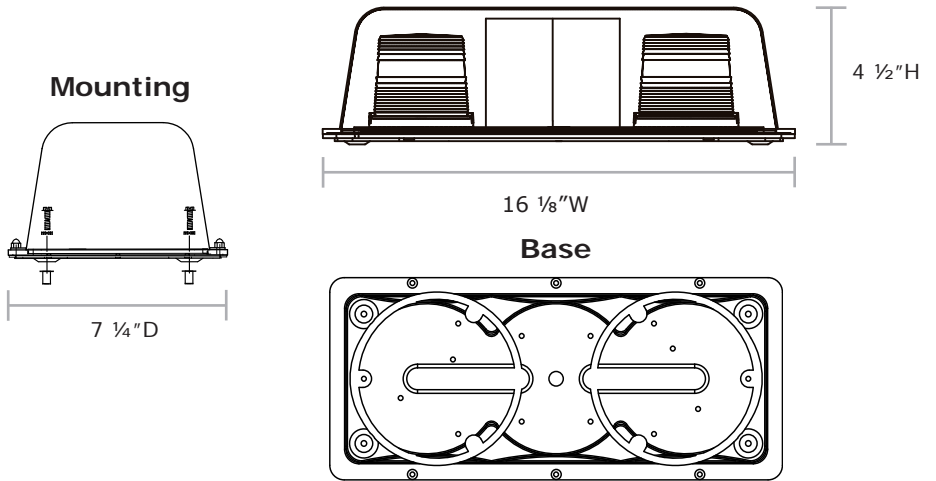

Replacement Parts (* = color)

Outer dome	920-3-*
Inner Fresnel lens	333-*
V-mirrors	820-29
Cig. plug	920-PAT20LO
Magnet (one)	920-16
Magnet kit (four)	920-16-4K
Vacuum magnet	920-16V

Part #	Description	Voltage	Amp Draw*	Weight	Approvals*
9200H8L-*	Ultra high intensity, permanent mount	10-30V DC	1.0 amps @ 12V DC	5 lbs.	Class I - A, B, C California Title 13 - A
9200HL-*	High intensity, permanent mount				SAE Class I - A Class II - B, C, R
9200H8LM-*	Ultra high intensity, magnet mount, cig. plug	10-16V DC	1.2 amps @ 12V DC	6 lbs.	Class I - A, B, C California Title 13 - A
9200HLM-*	High intensity, magnet mount, cig. plug				SAE Class I - A Class II - B, C, R
9200H8LV-*	Ultra high intensity, vacuum magnet mount, cig. plug			7 lbs.	Class I - A, B, C California Title 13 - A
9200HLV-*	High intensity, vacuum magnet mount, cig. plug				SAE Class I - A Class II - B, C, R

*Amp draw/Approvals will vary depending on the color of the LEDs and the flash pattern selected

Inner Lens Colors



Dome Colors



Warning: Cancer and Reproductive Harm - www.P65Warnings.ca.gov



Toll Free Fax Line: 1-888-478-2797
www.starheadlight.com





1500 - 51"



1400 - 44"

Phazer®

- Low profile high-intensity multi-function lightbar
- Rugged exterior with a heavy duty extruded aluminum base and UV stabilized polycarbonate lens
- Available in standard models or customizable configurations with only the heads and functions you need: Single or Dual-Color Heads (long and short), Traffic Director, Alley Lights, Takedown/Pursuit Lights, Intersection Clearing Lights, Worklights, Stop/Tail/Turn, Cruise Function, Dim option, California Title 13 Steady option, Emitter option
- Fully programmable flash patterns and head selection
- Fully programmable input wires including a progressive option
- Unique circuit design to protect against reverse polarity, voltage spikes, over current, and overheating
- LBC-CAN technology utilizes the Automotive industry standard CAN (Controller Area Network) protocol providing a highly reliable communication system
- Optional USB connectivity available for easy programming and cloning through a Windows based interface
- Optional hook mount kits are available for most current popular vehicle models
- US Patent D760,104

Available LED Head Options



Spot Optic (Starburst)

- 2.4" long
- S121-0-3* directional spot, 3 LED



Wide Spread Lineum

- 2.4" long
- S121-9-3* wide spread Lineum, 3 LED
- S121-9-6** wide spread Lineum, 3+3 Dual-color LED



Wide Spread Lineum

- 5.75" long
- S121-9L-6* wide spread Lineum, 6 LED
- S121-9L-9* wide spread super Lineum, 9 LED
- S121-9L-12** wide spread Lineum, 6+6 Dual-Color LED
- S121-9L-18** wide spread super Lineum, 9+9 Dual-Color LED

Part #	Dimensions	Voltage	Amp Draw★	Weight	Approvals★
1300 Series	2 1/8"H x 12"W x 37"L	10-16V DC	amps will vary	will vary	SAE Class I when properly configured
1400 Series	2 1/8"H x 12"W x 44"L				
1500 Series	2 1/8"H x 12"W x 51"L				
1550 Series	2 1/8"H x 12"W x 58"L		9.5 amps		
1600 Series	2 1/8"H x 12"W x 65"L				
1421LED-RB	2 1/8"H x 12"W x 44"L				
1521LED-RB	2 1/8"H x 12"W x 51"L				

★ Amp draw/Approvals will vary depending on the color of the LEDs and the flash pattern selected

To configure your Star Phazer® (choose which heads, etc.), please contact Star Headlight & Lantern Co., Inc. at 585-226-9787 or www.starheadlight.com

LED Colors



Dome Colors (Standard Clear)



1421LED-RB

- 44", Red/Blue, Starburst alleys, Starburst Takedown Pursuits, Traffic Director, long single (6) LED heads, short single (3) LED heads, Clear dome



1521LED-RB

- 51", Red/Blue, Starburst alleys, Starburst Takedown Pursuits, Traffic Director, long single (6) LED heads, short single (3) LED heads, Clear dome

Warning: Cancer and Reproductive Harm - www.P65Warnings.ca.gov

Phone Number: 585-226-9500
www.starheadlight.com





1421-ES Series - 44"



1521-ES Series - 51"

Phazer® Essential

- Economical low profile LED lightbar with Traffic Director option
- Choose from our standard models, or design your own layout
- Customizable heads, colors, and functions
- Extra bright PC amber Lineum LED heads
- Fifteen customer selectable warning flash patterns and twelve Traffic Director patterns
- Economically designed (electronics with only the features you need)
- Two flashing enables (ex. Front and Rear Enable), Steady Burn (Cruise, Alley Lights, Takedown or Worklights) and Traffic Director controls (Right, Left, Center Out)
- Option to replace steady burn function with dim function
- Lengths available: 44" or 51"

Pre Configured Models



1421-ES-RB

- Left, Right, Center Out, Front Flash, Rear Flash, Steady White
- 5 Red LED heads, 5 Blue LED heads, 8 PC Amber LED Traffic Director heads, 2 Takedown and 2 Alley LED heads, Clear domes



1401-ES-AA

- Left, Right, Center Out, Front Flash, Rear Flash, Steady White
- 14 PC Amber LED heads, Traffic Director Function, 2 Worklight and 2 Alley LED heads, Clear domes



1521-ES-RB

- Left, Right, Center Out, Front Flash, Rear Flash, Steady White
- 5 Red LED heads, 5 Blue LED heads, 8 PC Amber LED Traffic Director heads, 2 Takedown and 2 Alley LED heads, Clear domes

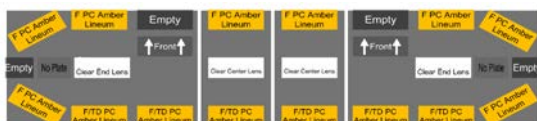

1501-ES-AA

- Left, Right, Center Out, Front Flash, Rear Flash
- 14 PC Amber LED heads, Traffic Director Function, Clear domes

	Wire Color	AWG	Function
1	Orange w/Red	18	Enable 1
2	Yellow	18	Enable 2
3	White w/Black	18	Steady burn/Aux
4	Orange w/Green	18	TD left
5	Green w/Yellow	18	TD right
6	Red	18	Power (12V)
7	Red w/Green	22	Pattern select
8	Black	14	Neutral (Ground)

Part #	Dimensions	Voltage	Amp Draw★	Weight	Approvals★
1401-ES-AA	2 ½"H x 12"W x 44"L	10-16V DC	amps will vary	will vary	SAE Class I when properly configured
1421-ES-RB	2 ½"H x 12"W x 44"L				
1501-ES-AA	2 ½"H x 12"W x 51"L				
1521-ES-RB	2 ½"H x 12"W x 51"L				

★ Amp draw/Approvals will vary depending on the color of the LEDs and the flash pattern selected

Warning: Cancer and Reproductive Harm - www.P65Warnings.ca.gov



Toll Free Fax Line: 1-888-478-2797
www.starheadlight.com





1550-TB



Phazer® Towbar

- Economical low profile LED lightbar with Stop/Tail/Turn and Worklights
- Choose from our standard models, or design your own layout
- Customizable heads, colors, and functions
- Extra bright PC Amber Lineum LED heads
- Twelve customer selectable flash patterns
- Economically designed (electronics with only the features you need)
- Compatible with seven power wire roll back tow trucks
- Power is drawn from the enable wires, no need for a constant hot wire (each input wire supplies input power for that function)
- Compatible with bulb out sensors
- Two flash enables (ex. Front and Rear enable)

	Wire Color	AWG	Function
1	Yellow	18	Left turn
2	Green	18	Right turn
3	White w/Orange stripe	18	Work/Flood Lights
4	Brown	18	Tail Lights/I.D.
5	Red	16	Enable 1
6	Red w/White stripe	16	Enable 2
7	Red w/Green stripe	22	Pattern Select
8	Black	14	Ground

Part #	Dimensions	Voltage	Amp Draw*	Weight	Approvals
1550-TB8-YR	2 1/2"H x 12"W x 58"L	10-16V DC	amps will vary	will vary	SAE Class I when properly configured
1550-TB10-Y					
1550-TB12-Y					

*Amp draw/Approvals will vary depending on the color of the LEDs and the flash pattern selected



1550-TB8-YR

- Towbar, 4 PC Amber/8 Red LED, Stop/Tail/Turn lights, Worklights, Clear domes



1550-TB10-Y

- Towbar, 10 PC Amber LED, Stop/Tail/Turn lights, Worklights, Clear domes



1550-TB12-Y

- Towbar, 12 PC Amber LED, Stop/Tail/Turn lights, Worklights, Clear domes

Warning: Cancer and Reproductive Harm - www.P65Warnings.ca.gov

Phone Number: 585-226-9500
www.starheadlight.com





7400 - 46"

STARLASER-X

Laser[®] X

- Full feature, heavy-duty, low profile LED lightbar with dual-color head capability
- Blend of innovative modular design, sculpted contours, exceptional strength, and durability
- Rugged Laser exterior, utilizing the dual top/bottom extruded aluminum beam design
- Bright Lineum LED heads, including the use of the extra bright PC amber heads
- Fully programmable
- Thirty-nine warning patterns to choose from
- Nine Traffic Director patterns
- Up to twelve independently controlled inputs
- SAE Class I when properly configured utilizing four corner heads
- Available in 46", 52" or 58" lengths



Spot Optic (Starburst)

- 2.4" long
- S731-0-3* Directional, 3 LEDs



Wide Spread Lineum

- 2.4" long
- S731-9-3* wide spread Lineum, 3 LEDs
- S731-9-6** wide spread Lineum, 3+3 Dual-color LEDs



Wide Spread Lineum

- 5.75" long
- S731-9L-6* wide spread Lineum, 6 LEDs
- S731-9L-9* wide spread Lineum, 9 LEDs
- S731-9L-12** wide spread Lineum, 6+6 Dual-Color LEDs
- S731-9L-18** wide spread super Lineum, 9+9 Dual-Color LEDs

Part #	Dimensions	Voltage	Amp Draw*	Weight	Approvals*
7400 Series	2 5/8"H x 12 1/4"W x 46"L	10-16V DC	will vary	will vary	SAE Class I when properly configured
7500 Series	2 5/8"H x 12 1/4"W x 52"L				
7600 Series	2 5/8"H x 12 1/4"W x 58"L				

*Amp draw/Approvals will vary depending on the color of the LEDs and the flash pattern selected

To configure your Star Laser[®]-X (choose which heads, etc.), please contact Star Headlight & Lantern Co., Inc., at 585-226-9787 or www.starheadlight.com

LED Colors



Dome Colors



Warning: Cancer and Reproductive Harm - www.P65Warnings.ca.gov



Toll Free Fax Line: 1-888-478-2797
www.starheadlight.com





7650-TB10-Y

Rear View

LASER® TOWBAR

- Economical heavy-duty, low profile LED lightbar with Stop/Tail/Turn and Worklights
- Choose from our standard models, or design your own layout
- Customizable heads, colors, and functions
- Extra bright PC amber Lineum LED heads
- Twelve customer selectable flash patterns
- Rugged exterior, extruded aluminium base and top, and UV stabilized polycarbonate lenses provide a lean, more assertive stance to any vehicle form
- Compatible with seven power wire roll back tow trucks
- Power is drawn from the enable wires, no need for a constant hot wire (each input wire supplies current for that function)
- Compatible with bulb out sensors
- Built in Stop/Tail/Turn functionality
- Two flash enables (ex. Front and Rear enable)
- One steady burn enable (ex. Worklights)
- Serviceability - top extrusion removes completely for easy access to modular components
- Choose standard models or design your own layout
- Customizable heads, colors, and function

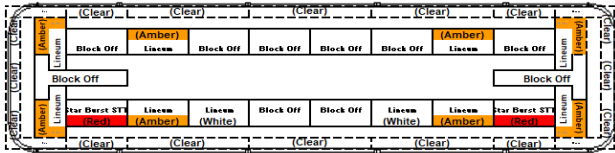

7650-TB10-Y

- Towbar, 8 PC Amber LED heads, Stop/Tail/Turn lights, Worklights, Clear domes

	Wire Color	AWG	Function
1	Yellow	18	Left turn
2	Green	18	Right turn
3	White w/Orange stripe	18	Work/Flood lights
4	Brown	18	Tail lights/I.D.
5	Red	16	Enable 1
6	Red w/White stripe	16	Enable 2
7	Red w/Green stripe	22	Pattern Select
8	Black	14	Ground

Part #	Dimensions	Voltage	Amp Draw*	Weight	Approvals*
7650-TB10-Y	2 5/8"H x 12 1/4"W x 58"L	10-16V DC	amps will vary	will vary	Class I when properly configured

*Amp draw/Approvals will vary depending on the color of the LEDs and the flash pattern selected

LED Colors



Front Lens and End Cap Colors (Standard Clear)



Warning: Cancer and Reproductive Harm - www.P65Warnings.ca.gov

Phone Number: 585-226-9500
www.starheadlight.com





Vehicle Specific Mount Kits

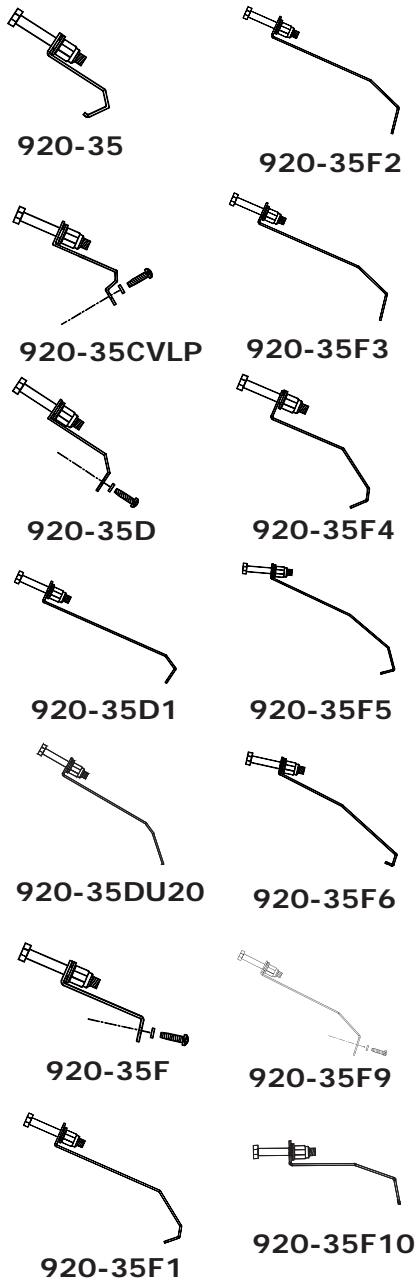

Chevrolet Models	Style	Beginning Year	Through Year	Model Number	Flex Models
Avalanche	Wrap-around doors	2002	2013	920-35-S105	920-35FX1
C/K Pickup 1500		1999	2010		
C/K Pickup 2500, 3500		2001	2010		
Caprice	Standard roof	2011	2017	920-35GM7	920-35FX2
Colorado	Wrap-around doors	2004	2012	920-35GM6	
Impala		2006	2013	920-35I6	
Silverado/Sierra		2001	2013	920-35-S105	
Silverado		2014	2022	920-35GM8	
Suburban		2007	2014	920-35GM5	
Suburban		2015	2020	920-35GM8	
Tahoe (older)		2007	2014	920-35GM5	
Tahoe		2015	2022	920-35GM8	
Trailblazer		2007	2009	920-35-S105	

Dodge Models	Style	Beginning Year	Through Year	Model Number	Flex Models
Avenger	Wrap-around doors	2008	2014	920-35D	920-35FX1
Charger		2005	2007	920-35M1	
Charger		2008	2022	920-35CH	920-35FX2
Dakota (Reg. Ext., Crew)		1997	2011	920-35GM	920-35FX1
Dakota		2006		920-35F	
Dart		2013	2013	920-35D	
Durango		2004	2020	920-35-S105	
Durango		2021	2022	920-35DU20	
Ram Pickup (Crew)		2003	2007	920-35RM5	
Ram Pickup (Reg.)				920-35RM2	
Ram Pickup (1500, 2500, 3500)	2008	2022	920-35RM3	920-35FX2	

 **Warning:** Cancer and Reproductive Harm - www.P65Warnings.ca.gov



Toll Free Fax Line: 1-888-478-2797
www.starheadlight.com



Vehicle Specific Mount Kits

Ford Models	Style	Beginning Year	Through Year	Model Number	Flex Models
Crown Victoria	Wrap-around doors	1992	2011	920-35CVLP	920-35FX1
Edge		2011	2013	920-35F3	920-35FX3
E-450		2003	2009	920-35F6	
E-Series (van)	Standard roof	1987	2020	920-35	920-35FX1
Expedition	Wrap-around doors	2003	2020	920-35FT	920-35FX3
Explorer			2019	920-35F3	
F-Series (150)		2007	2022	920-35F1	920-35FX3
F-Series (250, 350, 450, 550)				920-35F2	
F-Series (250, 350, 450)				2003	
Interceptor	2012	2019	920-35F5	920-35FX3	
LTD-Crown Victoria		1992	2011	920-35CVLP	920-35FX1
PI SUV	Wrap-around doors	2020	2022	920-35F10	920-35FX2
Taurus Interceptor (Sedan)		2010	2021	920-35F3	920-35FX3

Toyota Models	Style	Beginning Year	Through Year	Model Number	Flex Models
Hilux	Wrap-around doors	2010	2019	920-35F	920-35FX1
Tacoma					



920-35FT



920-35FI

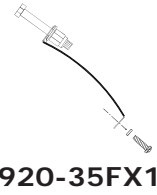

920-35FX1

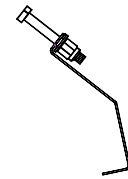

920-35FI 6

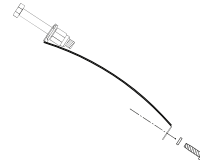

920-35FX2

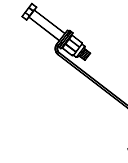

920-35INT

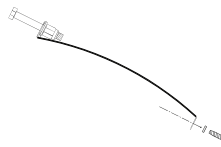

920-35FX3



920-35IZ

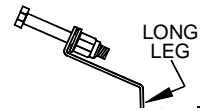

920-35GM

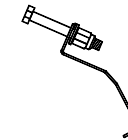

920-35M1

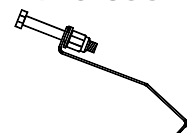

920-35GM2

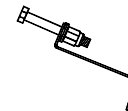

920-35RM2

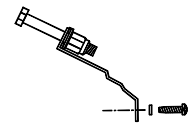

920-35GM5

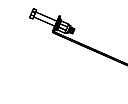

920-35RM3

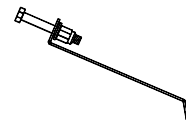

920-35GM6

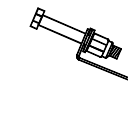

920-35RM5

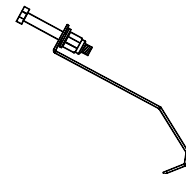

920-35GM7



920-35S105

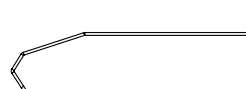

920-35GM8

Warning: Cancer and Reproductive Harm - www.P65Warnings.ca.gov

Phone Number: 585-226-9500
www.starheadlight.com





60 Series

- Heavy duty back-up alarm
- Built for long term reliability
- Standard beep: 60 BPM single tone, familiar and widely recognized "reverse" tone (does not apply to DT versions)
- Convenient compact size available in a range of decibel options
- Perfect for a wide range of vehicle applications
- Rugged cast aluminium housing
- Industry standard mounting
- Decibel level: Sound pressure level should be selected based on the ambient noise of your work site and any applicable regulations such as OSHA

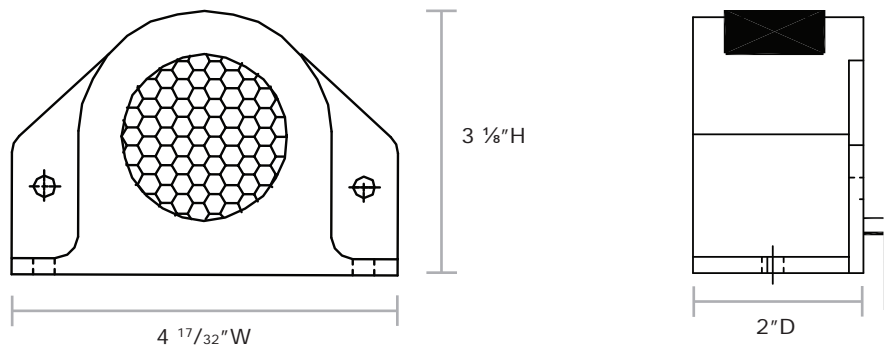

Part #	Description	Decibels	Voltage	Amp Draw	Weight
60-087	Single tone	87 dB	10-32V DC	0.3 amps @12V DC	2 lbs.
60-097		97 dB			
60-097DT	Dual tone warning device	102 dB			
60-102	Single tone				
60-102DT	Dual tone warning device	107 dB			
60-107	Single tone				
60-707A	Starmatic™ Auto Adjust	77-97 dB			
60-802A		82-102 dB			
60-802S	Selectable output level	87-102 dB			
60-807A	Starmatic™ Auto Adjust	87-107 dB			
60-907S	Selectable output level	97-107 dB			

Warning: Cancer and Reproductive Harm - www.P65Warnings.ca.gov



Toll Free Fax Line: 1-888-478-2797
www.starheadlight.com





63 Series

- Compact grommet-mount back-up alarm
- Long term reliability
- Convenient compact size
- Available in a range of decibel options perfect for a wide range of vehicle applications
- Standard beep: sixty BPM single tone, familiar and widely recognized "reverse" tone (does not apply to DT versions)
- Heavy duty polycarbonate housing
- Standard 4" grommet mount (fits 4 1/2" hole)
- Decibel level: sound pressure level should be selected based on the ambient noise of your work site and on any applicable regulations such as OSHA

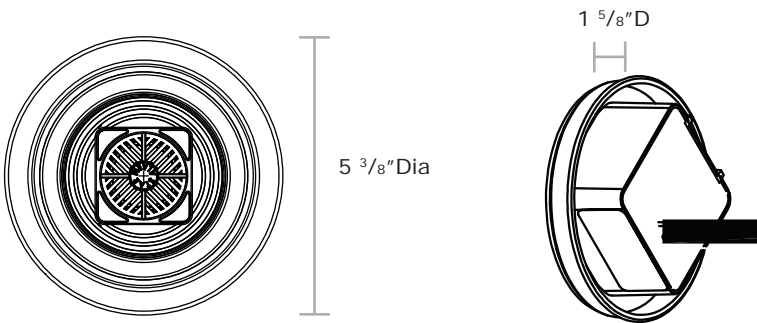

Part #	Description	Decibels	Voltage	Amp Draw	Weight	Approvals
63-087	Single Tone	87 dB	12-36V DC	0.3 amps @ 12V DC	1 lb.	SAE J994 Type D
63-097		97 dB				SAE J994 Type C
63-102		102 dB				SAE J994 Type F
63-107		107 dB				SAE J994 Type B
63-097DT	Dual-Tone warning device	97 dB	12-24V DC			N/A
63-102DT		102 dB				
63-707A	Auto-Adjusting	77-97 dB	12-24V DC			N/A
63-802A		82-102 dB				
63-807A		87-107 dB	12V only			

Warning: Cancer and Reproductive Harm - www.P65Warnings.ca.gov

Phone Number: 585-226-9500
www.starheadlight.com





66L Series



66 Series

66 Series

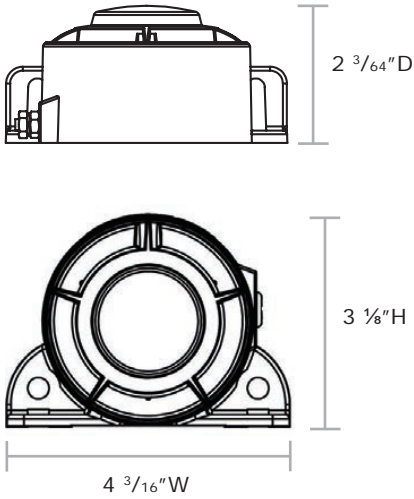

- Compact, rear-facing back-up alarm with a heavy duty glass filled nylon housing
- CRS Technology™
- Long-term reliability
- Available in a variety of decibel options
- Industry-standard mounting holes
- Unique patented design provides superior protection to the speaker from the damage often caused by high-pressure spray, dirt, and fine dust!
- Standard beep: standard single tone, familiar and widely recognized “reverse” tone
- Dual Tone “DT”: constant emission of sound by switching between two sounds
- Dual Function “DF”: alarm has two input wires, each activating a distinct tone, allowing the alarm to be connected to two independent functions
- Selectable decibel “S”: select between two loudness levels by applying voltage to a third wire
- Auto-adjust “A”: automatically adjusts its volume based on the ambient noise
- Wired versions or Lug versions (L models) available

Part #	Description	Decibels	Voltage	Amp Draw	Weight	Approvals
66-087	Two wire, Single	87 dB	10-32V DC	0.3 amps @ 12V DC	2 lbs.	SAE J994, Type D
66-097		97 dB				SAE J994, Type C
66-097DF	Three wire, Dual Function					
66-097DT	Two wire, Dual Tone warning device					
66-102	Two wire, Single					
66-102DT	Two wire, Dual Tone warning device	102 dB				
66-107	Two wire, Single	107 dB				
66-707A	Two wire, Auto Adjusting	77-97 dB				
66-802A	Two wire, Auto Adjusting	82-102 dB				
66-802S	Three wire, Selectable	82 or 102 dB				
66-807A	Two wire, Auto adjusting	87-107 dB				
66-907S	Three wire, Selectable	97-107 dB				
66L-087	Lugs only, Single	87 dB				
66L-097		97 dB				SAE J994, Type D
66L-097DT	Lugs only, Dual Tone warning device					SAE J994, Type C
66L-102	Lugs only, Single					
66L-102DT	Lugs only, Dual Tone warning device		102 dB			
66L-107	Lugs only	107 dB				
66L-707A	Lugs only, Auto Adjusting	77-97 dB				
66L-802A		82-102 dB				
66L-807A		87-107 dB				

Warning: Cancer and Reproductive Harm - www.P65Warnings.ca.gov



Toll Free Fax Line: 1-888-478-2797
www.starheadlight.com





64 Series

- Compact back-up alarm with glass-filled nylon housing
- Industry standard mounting footprint
- Polarity protected
- Connections: 12" Red wire with 16-18 AWG butt splice, 3" Black wire with 1/4" ring terminal
- Rated: IP67

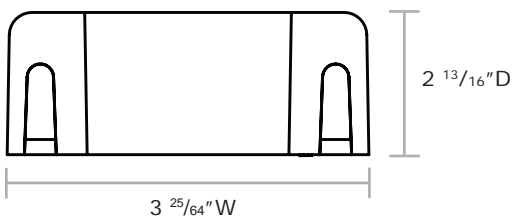
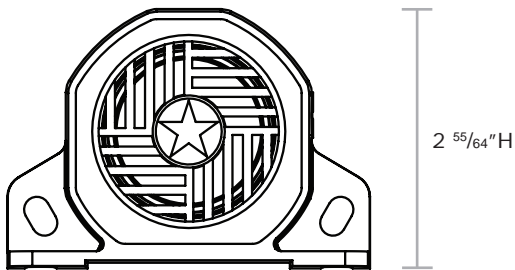

Part #	Description	Decibels	Voltage	Amp Draw	Weight	Approvals
64-097	Single tone	97 dB	12-48V DC	.13 amps @ 12V DC	1 lb.	SAE J994 Type C
64-102		102 dB	12-24V DC			SAE J994 Type F
64-107		107 dB				SAE J994 Type B

Warning: Cancer and Reproductive Harm - www.P65Warnings.ca.gov

Phone Number: 585-226-9500
www.starheadlight.com





68 Series

- Full size, rear facing back up alarm with a heavy duty glass filled nylon housing
- Unique patented design utilizing CRS technology™ provides superior protection to the speaker from the damage often caused by high-pressure spray, dirt, and fine dust! (US Patent D796,367)
- Long-term reliability
- Standard Beep: 60 BPM single tone, familiar and widely recognized “reverse” tone
- Industry standard mounting
- Three connection options available: wires, lugs, or two-conductor cable

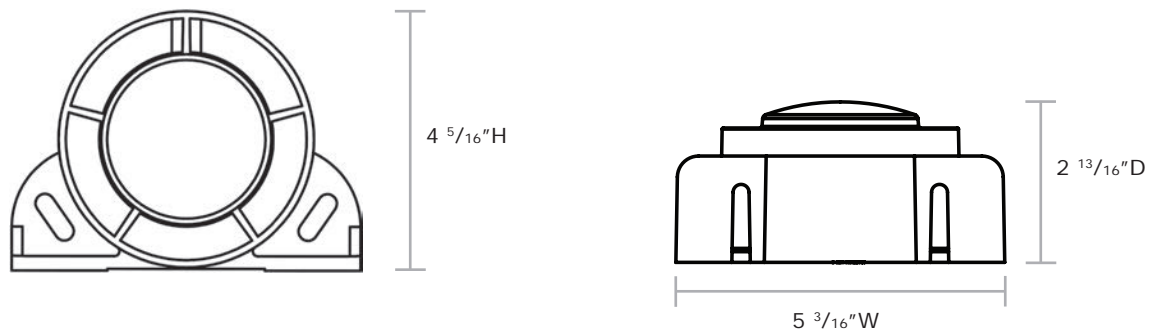

Part #	Description	Decibels	Voltage	Amp Draw	Weight	Approvals			
68-112	Wire leads, Single tone	112 dB	10-32V DC	0.4 amps @ 12V DC	2 lbs.	SAE J994, Type A			
68C-112	Two conductor cable, Single tone								
68L-112	Lugs only, Single tone								
68-812A	Auto adjusting, Single	87-112 dB				10-32V DC	0.4 amps @ 12V DC	2 lbs.	SAE J994 Type F
68C-812A	Auto Adjust, Two conductor cable								
68L-812A	Auto adjusting, Lugs only								

Warning: Cancer and Reproductive Harm - www.P65Warnings.ca.gov



Toll Free Fax Line: 1-888-478-2797
www.starheadlight.com





66 Series



66L Series

66 Spectrum Series

- CRS technology™ offers a compact, rear facing speaker with a heavy duty glass filled nylon housing
- Rich audible tones combined with familiar sound of a traditional warning alarm
- Individually programmed through a proprietary fixture that incorporates the optimal frequency into each alarm
- Spectrum “SS”: Composite of multiple tones, referred to as “multi frequency”, tighter frequency range, more universally recognizable warning tone, emits a composite buzz tone

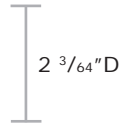
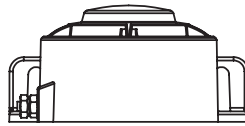
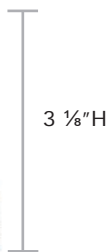
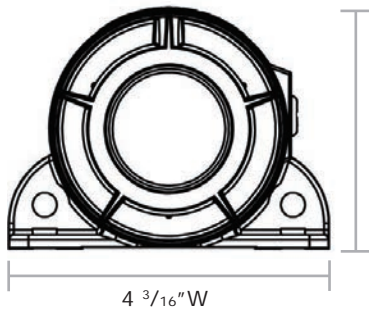

Part #	Description	Decibel	Voltage	Amp Draw	Weight	Approvals
66-087SS	Two wire	87 dB	10-32V DC	0.3 amps @ 12V DC	2 lbs.	N/A
66-092SS		92 dB				
66-097SS		97 dB				
66L-097SS	Lugs only	97 dB				

Warning: Cancer and Reproductive Harm - www.P65Warnings.ca.gov

Phone Number: 585-226-9500
www.starheadlight.com





SB4020T



SB4020



SB4040



SB4425T



SP1515



SB3015

Switch Boxes and Switch Panels

- All switches are illuminated
- Legends are back lit for easy night usage
- High/Low switches include one switch that is Ground-side switched for lights that control High/Low power by switching Ground to the control wire
- Ships complete with legends (excludes SB1515, SB3015, SP1515, and SP3015), mounting brackets, hardware and instructions

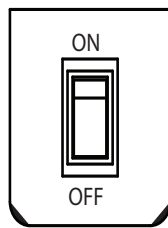

2"W
SP3860-1

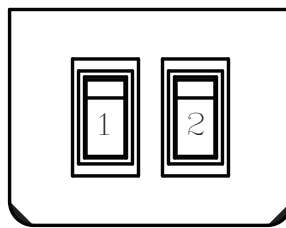

2 15/16"W
SP3860-2, SP3860-2H

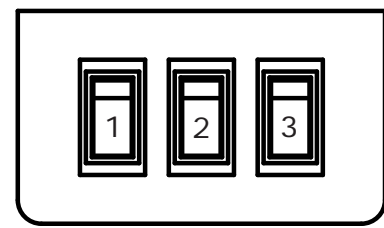

3 7/8"W
SP3860-3, SP3860-3H

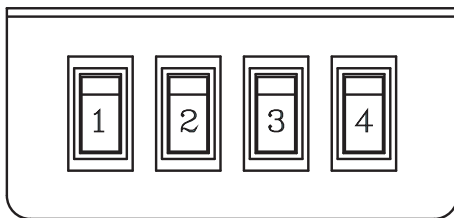

4 13/16"W
SP3860-4, SP3860-4H

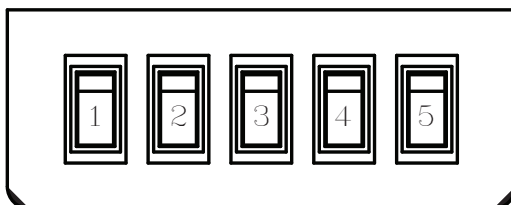

5 3/4"W
SP3860-5

Part #	Description	Weight
SB1515	Enclosed switch box, (4) 15 amp switches	2 lbs.
SB3015	Enclosed switch box, (1) 30 amp switch, (3) 15 amp switches	2 lbs.
SB4020	(1) 40 amp switch, (5) 20 amp switches, 2' wire harness	5 lbs.
SB4020-15	(1) 40 amp switch, (5) 20 amp switches, 15' wire harness	
SB4020T	(1) 40 amp switch, (5) 20 amp switches, nine position terminal block	5 lbs.
SB4040	(4) 20 amp switch, (1) three mode 40 amp, progressive slide switch, 2' wire harness	
SB4040-15	(4) 20 amp switch, (1) three mode 40 amp progressive slide switch, 15' wire harness	3 lbs.
SB4425T	(1) On/Off master power switch, (4) 40 amp switches, (5) 20 amp switches	
SP1515	Switch panel, (4) 15 amp switches	2 lbs.
SP3015	Switch panel (1) 30 amp switch, (3) 15 amp switches	2 lbs.
SP3860-1	On/Off	1 lb.
SP3860-2	On/Off, On/Off	
SP3860-2H	On/Off, High/Low	2 lbs.
SP3860-3	On/Off, On/Off, On/Off	
SP3860-3H	On/Off, High/Low, On/Off	3 lbs.
SP3860-4	On/Off, On/Off, On/Off, On/Off	
SP3860-4H	On/Off, High/Low, On/Off, On/Off	3 lbs.
SP3860-5	On/Off, On/Off, On/Off, On/Off, On/Off	

Warning: Cancer and Reproductive Harm - www.P65Warnings.ca.gov



Toll Free Fax Line: 1-888-478-2797
www.starheadlight.com





SB44-5

- Five-button standard Traffic Director control options and auxiliary switches
- Built-in LED display mimics Traffic Director output
- Red backlit silicone rubber keypad with 14 programmable brightness settings
- Option to program as a 4-output switchbox
- Durable polycarbonate housing
- Hardwired 11" pigtail
- Includes aluminum U-bracket (274-SB44-U) and stainless steel hardware for versatile mounting
- Includes replaceable velvet finish Lexan™ button labels

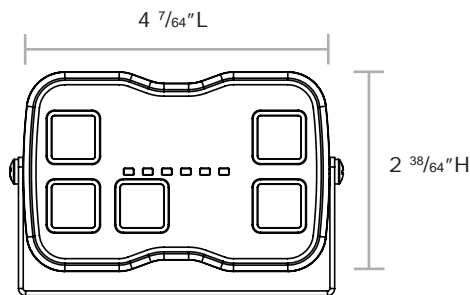

Part #	Description	Operating Range	Output	Weight
SB44-5	Programmable switchbox, 5 buttons	9-16V DC	2 outputs @ 2.5A average 2 outputs @ 0.06A average	2 lbs.

Warning: Cancer and Reproductive Harm - www.P65Warnings.ca.gov

Phone Number: 585-226-9500
www.starheadlight.com





SB44-8

- Control panel for operating up to eight lights/devices
- Built-in LED display mimics Traffic Director output
- Programmable switching options: Ground-side switching, Momentary switching, Normally Closed, Flashing Output with Pattern Selection and Phase settings, and Audio feedback
- Red backlit silicone rubber keypad with 14 programmable brightness settings
- Option to program as a stand-alone Traffic Director Controller for logic-controlled sticks
- Smartphone programmable
- Durable polycarbonate housing
- Detachable 12-pin wire harness included to simplify installation
- Includes aluminum U-bracket (274-SB44-U) and stainless steel hardware for versatile mounting
- Includes replaceable velvet finish Lexan™ button labels

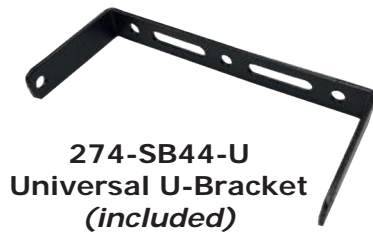

274-SB44-U
Universal U-Bracket
(included)



274-SB44-H
Headliner Bracket
(optional)



274-SB44-ULP
Low Profile Bracket
(optional)



274-SB44-VC
Visor Clip Bracket
(optional)

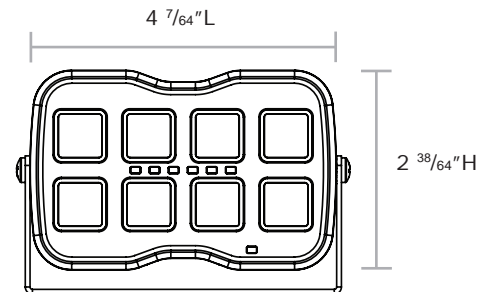

Part #	Description	Operating Range	Output	Weight
SB44-8	Programmable switchbox, 8 buttons	9-16V DC	6 outputs @ 2.5A average 2 outputs @ 0.06A average	2 lbs.

Warning: Cancer and Reproductive Harm - www.P65Warnings.ca.gov



Toll Free Fax Line: 1-888-478-2797
www.starheadlight.com





BBK274-FL



BBK274-FH

(Lights sold separately)



Ford F-Series Shelf Bracket

- This bracket mounts to the existing vehicle third brake light holes and provides a mounting surface that eliminates the need for drilling any holes in your vehicle when mounting your beacons and minibars
- Lightweight aluminum
- F-150, F-250, F-350 model years 2019 - 2022
- Minibars - 9100LED, 9200, 9016LED, 9018LED, 9900LED, 9901LED
- Beacons - 255, 256, 266, 281, 200A
- Flood lights - Golight RadioRay, KH Industries NightRay
- BB274-PLATE Optional steel mounting plate for magnet mount lights



BBK274-FH-P



BBK274-PLATE

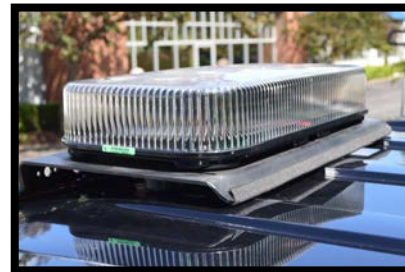

Part #	Description	Weight
BBK274-FH	Roof shelf bracket for Ford Series Truck, Halogen brake light version	5 lbs.
BBK274-FL	Roof shelf bracket for Ford Series Truck, LED brake light version	
BBK274-FL-P	Roof shelf bracket for Ford Series Truck, magnet mount plate, LED brake light version	8 lbs.
BBK274-FH-P	Roof shelf bracket for Ford Series Truck, magnet mount plate, Halogen brake light version	
BBK274-PLATE	Magnet mount plate	3 lbs.

Warning: Cancer and Reproductive Harm - www.P65Warnings.ca.gov

Phone Number: 585-226-9500
www.starheadlight.com





510-1M

Worklights Sealed Beam

Part #	Description	Weight
510	Clear, sealed beam, 3000cp	2 lbs.
510-1	Clear, sealed beam with On/Off switch, 3000cp	
510-1M	Clear, sealed beam with magnet mount and cig. plug and On/Off, 3000cp	3 lbs.
510-4509	Clear, high intensity sealed beam, 3000cp	2 lbs.
510-M	Clear, sealed beam with magnet mount and cig. plug, 3000cp	3 lbs.
511	Sealed beam with lens shield, 3000cp (lens colors A, B, R, W)	2 lbs.
511-1M	Clear sealed beam with magnet mount and cig. plug, 3000cp (lens colors: A, B, R, W)	3 lbs.

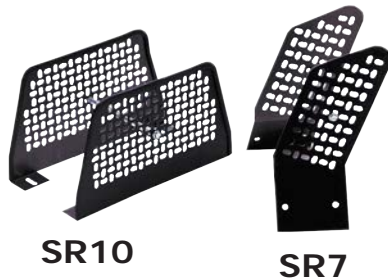

SR10

SR7



274-SL



274-SL1

Accessories Organizers, Brackets



500-J

274-LMB

Part #	Description	Weight
SR7	Vertical mount two unit organizer, 12 1/2"H x 4 5/16"D	2 lbs.
SR9	Vertical mount three unit organizer, 13 1/2"H x 4 5/16"D	
SR10	Horizontal mount three unit organizer, 7"H x 12"D	2.5 lbs.
SR12	Horizontal mount four unit organizer, 7"H x 14"D	
274-SL	Self-leveling bracket, 11"H x 4 1/4"D, two holes on 6 1/4 centers	9 lbs.
274-SL1	Self-leveling bracket for Star Mini-Bars®, 11"H x 4 1/4"D, three holes on 5 3/4" centers	5 lbs.
274-LMB	L-bracket for mirror blackout, 8"H x 8"W x 8"D	2 lbs.
500-J	Car Inspector Lantern with LED 2012 head, 7 1/2"H x 4 3/4"W x 6 3/4"D	4 lbs.

Warning: Cancer and Reproductive Harm - www.P65Warnings.ca.gov



Toll Free Fax Line: 1-888-478-2797
www.starheadlight.com





back

SS670-013

- Full feature 100 watt siren with seven-position function knob, Manual and Air Horn buttons, PA and Radio Repeat
- Installer programmable tone: eight Siren tones, ten Manual and Aux tones and eight Air Horn tones
- Integrated public address microphone, with user-adjustable Volume knob
- LED diagnostics allow quick troubleshooting
- On/Off rocker switch
- Auxiliary input allows for remote activation of the Manual function, Air Horn, or Hands Free Tone Cycling
- Siren protected by both a 15 amp user-replaceable fuse and built-in self-resetting circuit protection
- Reverse polarity protection
- High and low voltage shutdown protection
- Ships complete with positive locking connector, mic clip, mounting bracket, hardware, and instructions
- Designed for use with one 100 watt speaker

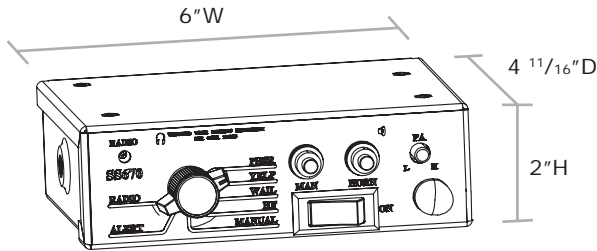

Part #	Description	Input	Output	Amp Draw	Frequency	Weight	Approvals
SS670-013	Full function siren with PA and Radio Repeat	10-16V DC	100 watts 1 speaker	8 amps	675-3000Hz	5 lbs.	Exceeds acoustical and environmental requirements, SAE J1849 California Title 13

Warning: Cancer and Reproductive Harm - www.P65Warnings.ca.gov

Phone Number: 585-226-9500
www.starheadlight.com





back



SS700-016

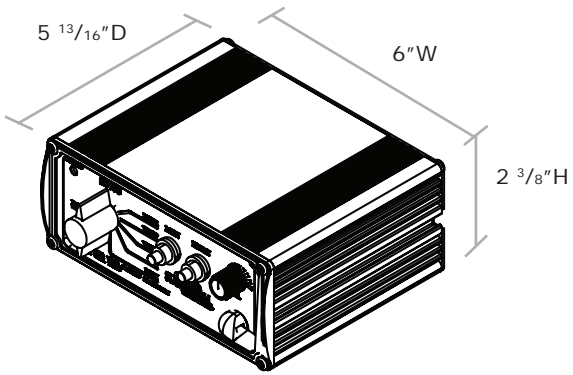

- Full feature 200 watt siren with flush mount control head and remote amplifier
- Seven position rotary switch (Radio, Alert, Manual, Hands Free, Wail, Yelp, Phazer), Manual and Air Horn buttons, and Radio Repeat
- Installer programmable tones: eighteen siren tones, ten Manual and Aux tones, and eight Air Horn tones
- Integrated public address microphone with user adjustable Volume knob
- On/Off rocker switch
- Designed for use with one or two 100 watt speakers
- Auxiliary input (positive or negative switched) Air Horn or Hands Free Tone Cycling
- Diagnostic LED allows for quick troubleshooting
- Fully protected unit with high and low voltage shutdown, reverse polarity protection, built-in self-resetting audio circuit protection, and a user replaceable fuse
- Easily retrofit existing harnesses with only a wire stripper and screw driver
- Ships complete with positive locking wiring connector, mic clip, U-bracket, hardware, and instructions

Part #	Description	Input	Output	Amp Draw	Frequency	Weight	Approvals
SS700-016	Full feature siren with visual LED diagnostics with extruded housing	10-16V DC	200 watts 1 or 2 speakers	8 amps per speaker	675-3000Hz	6 lbs.	Exceeds acoustical and environmental requirements, SAE J1849 California Title 13
SS700-28-016		19-32V DC					

Warning: Cancer and Reproductive Harm - www.P65Warnings.ca.gov



Toll Free Fax Line: 1-888-478-2797
www.starheadlight.com





SS730

- Full feature 200 watt siren with flush mount control head and remote amplifier
- Seven position rotary switch (Radio, Alert, Manual, Hands Free, Wail, Yelp, Phazer), manual and air horn buttons, and radio repeat
- Integrated public address microphone with user adjustable Volume knob
- On/Off rocker switch
- Designed for use with one or two 100 watt speakers
- Park Kill input (positive or negative switched)
- Auxiliary input (positive or negative switched) Air Horn or Hands Free Tone Cycling
- Diagnostic LEDs allow for quick troubleshooting
- Fully protected unit with high and low voltage shutdown, reverse polarity protection, built-in self-resetting audio circuit protection, and a user replaceable fuse
- Ships complete with positive locking wiring connector, mic clip, and instructions

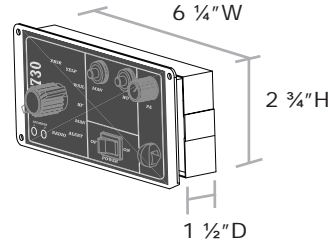
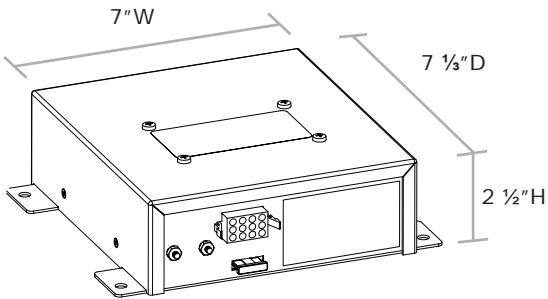

Part #	Description	Input	Output	Amp Draw	Frequency	Weight	Approvals
SS730	Full feature siren with remote amp	10-16V DC	100 or 200 watts 1 or 2 speakers	8 amps per speaker	675-3000Hz	6.5 lbs.	Exceeds acoustical and environmental requirements, SAE J1849 California Title 13 AMECA listed (when used with StarSignal speaker drivers and approved tones)

Warning: Cancer and Reproductive Harm - www.P65Warnings.ca.gov

Phone Number: 585-226-9500
www.starheadlight.com





back

SS741MG-11

- Full feature dual-tone 200 watt siren with flush mount control head and remote amplifier
- Seven position rotary switch (Radio, Alert, Manual, Hands Free, Wail, Yelp, Phazer), Manual and Air Horn buttons, and Radio Repeat
- Dual-Tone (Magnum) mode allows a single vehicle to sound like several vehicles
- Integrated public address microphone with user adjustable volume knob
- On/Off rocker switch
- Designed for use with one or two 100 watt speakers
- Park Kill input (positive or negative switched)
- Auxiliary input (positive or negative switched) Air Horn or Hands Free Tone Cycling
- Diagnostic LEDs allow for quick troubleshooting
- Fully protected unit with high and low voltage shutdown, reverse polarity protection, built-in self-resetting audio circuit protection, and a user replaceable fuse
- Ships complete with positive locking wiring connector, mic clip, and instructions

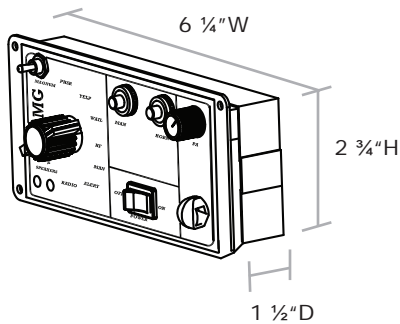
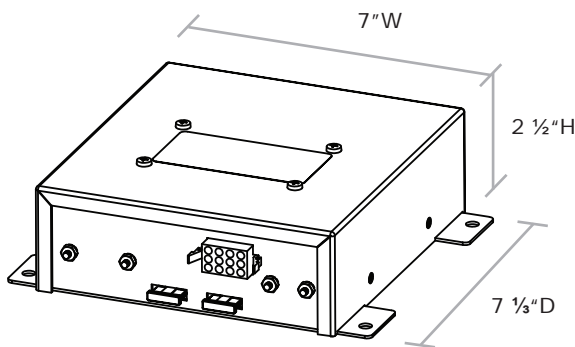

Part #	Description	Input	Output	Amp Draw	Frequency	Weight	Approvals
SS741MG-11	Magnum siren, two modes of operation, visual LED diagnostics	10-16V DC	100 or 200 watts 1 or 2 speakers	8 amps	675-3000Hz	9 lbs.	Exceeds acoustical and environmental requirement, SAE J1849 California Title 13, AMECA listed (when used with StarSignal drivers and approved tones)

Warning: Cancer and Reproductive Harm - www.P65Warnings.ca.gov



Toll Free Fax Line: 1-888-478-2797
www.starheadlight.com





Amplifier



Control Head

SS651MT-013

- Economy 100 watt siren and light controller with remote amplifier and weatherproof control head
- Designed for motorcycle or marine applications
- Wail, Yelp, and Phaser tones
- Installer programmable tones: eighteen Siren tones, ten Auxiliary tones, and eight Air Horn tones
- Controls two additional lights or functions
- Designed for use with one 100 watt speaker
- Park Kill input (positive or negative switched)
- Auxiliary input (positive or negative switched) for Air Horn or Hands Free Tone Cycling
- Diagnostic LED allows for quick troubleshooting
- Fully protected unit with high and low voltage shutdown, reverse polarity protection, built-in self-resetting audio circuit protection, and a user replaceable fuse
- Ships complete with positive locking wiring connector, hardware, and instructions

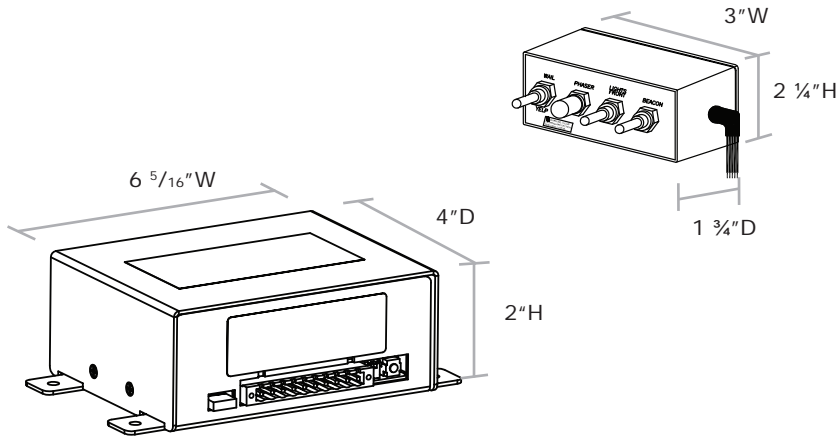

Part #	Description	Input	Output	Amp Draw	Frequency	Weight	Approvals
SS651MT-013	Economy siren for motorcycle	10-16V DC	100 watts 1 speaker	8 amps	675-3000Hz	3.5 lbs.	Exceeds acoustical and environmental requirements, SAE J1849 California Title 13

Warning: Cancer and Reproductive Harm - www.P65Warnings.ca.gov

Phone Number: 585-226-9500
www.starheadlight.com





SS651



SS650-013



Amplifier

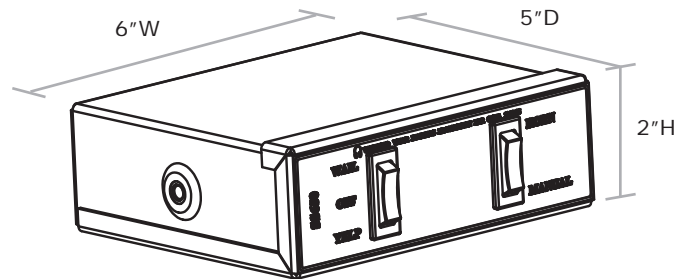
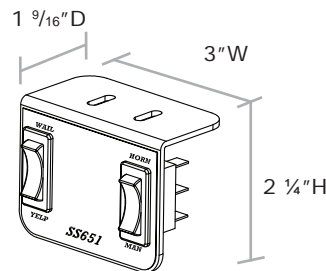
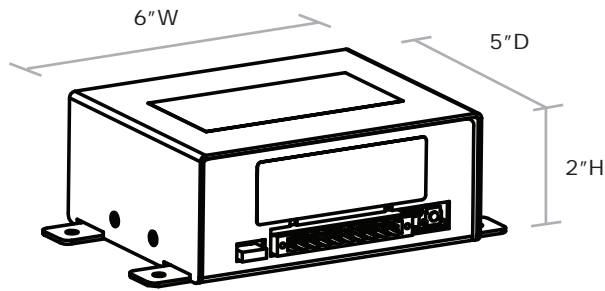

SS650-013, SS651-013

- Economy Siren with Air Horn
- Combines small size with big power
- Ideal for volunteer and vehicles with limited mounting space
- The SS650 combines the control panel and amp into one compact unit
- The SS651 utilizes a small control panel and a remote amplifier
- Primary operating modes: Wail, Yelp, Standby, Air Horn, and Manual
- Drives one 100 watt speaker
- Installer programmable tones: eighteen Siren tones, ten Manual and Auxiliary tones, and eight Air Horn tones
- Auxiliary input (positive or negative switched) for Air Horn or Hands Free Tone Cycling
- Diagnostic LED allows for quick troubleshooting
- Fully protected unit with high and low voltage shutdown, reverse polarity protection, built-in self-resetting audio circuit protection, and a user-replaceable fuse
- Easily retrofit existing harnesses with only a wire stripper and screwdriver
- Ships complete with positive locking wiring connector, U-bracket (SS650 only), hardware, and instructions

Part #	Description	Input	Output	Amp Draw	Frequency	Weight	Approvals
SS650-013	Four mode economy siren	10-16V DC	100 watts 1 speaker	8 amps	675-3000Hz	3.5 lbs	Exceeds acoustical and environmental requirements, SAE J1849 California Title 13
SS651-013	Four mode economy siren and separate switch panel						

Warning: Cancer and Reproductive Harm - www.P65Warnings.ca.gov



Toll Free Fax Line: 1-888-478-2797
www.starheadlight.com





LCS652-013



LCS653-013



LCS652-013, LCS653-013

- Economy Siren with light control
- Combines small size with big power
- Ideal for volunteer and vehicles with limited mounting space
- Features the flexibility to control lighting or auxiliary functions with a 15 amp On/Off switch
- The LCS652-013 combines the control panel and amp into one compact unit (two auxiliary switches)
- The LCS653-013 utilizes a small control panel and a remote amplifier (two auxiliary switches)
- The LCS653-1-013 utilizes a small control panel and a remote amplifier (one auxiliary switch)
- Primary operating modes: Wail, Yelp, Standby, Air Horn, and Manual
- Drives one 100 watt speaker
- Installer programmable tones: eighteen Siren tones, ten Manual and Auxiliary tones, and eight Air Horn tones
- Auxiliary input (positive or negative switched) for Air Horn or Hands Free Tone Cycling
- Diagnostic LED allows for quick troubleshooting
- Fully protected unit with high and low voltage shutdown, reverse polarity protection, built-in self-resetting audio circuit protection, and a user-replaceable fuse
- Easily retrofit existing harnesses with only a wire stripper and screwdriver
- Ships complete with positive locking wiring connector, U-bracket (LCS652 only), hardware, and instructions

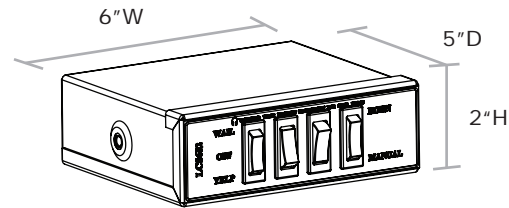

LCS652-013

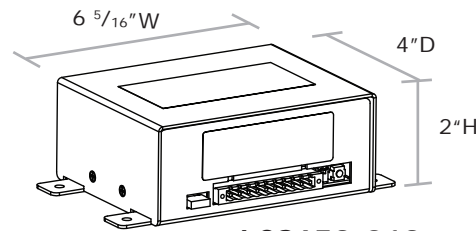

LCS653-013

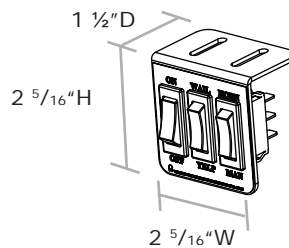

LCS653-1-013
switch panel

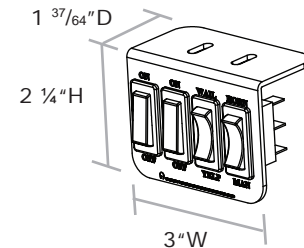

LCS653-013
switch panel

Part #	Description	Input	Output	Amp Draw	Frequency	Weight	Approvals
LCS652-013	Economy siren with two lighting controls	10-16V DC	100 watts 1 speaker	8 amps	675-3000Hz	3.5 lbs.	Exceeds acoustical and environmental requirements, SAE J1849, California Title 13
LCS653-013	Economy siren with two lighting controls and remote amps						
LCS653-1-013	Economy siren with one auxiliary power switch and remote amp						

Warning: Cancer and Reproductive Harm - www.P65Warnings.ca.gov

Phone Number: 585-226-9500
www.starheadlight.com





back



LCS770

LCS770

- Full feature 200 watt siren and PA with slide switch and push button light controls
- Seven position rotary switch (Radio, Alert, Manual, Hands Free, Wail, Yelp, Phaser)
- Manual and Air Horn push buttons
- Controls up to seven different lights/functions
- Four-position progressive slide switch with LED indicators
- Four lighted push buttons for auxiliary lighting/functions
- Integrated public address microphone with user adjustable Volume knob (combination Volume and On/Off)
- Drives one or two 100 watt speakers
- Gun Lock option
- Park Kill input (positive or negative switched)
- Auxiliary input (positive or negative switched) for Air Horn or Hands Free Tone Cycling
- Diagnostic LEDs allow for quick troubleshooting
- Fully protected unit with high and low voltage shutdown, reverse polarity protection, built-in self-resetting audio circuit protection, and user-replaceable fuses
- Ships complete with positive locking wiring connector, mic clip, U-bracket, hardware, and instructions

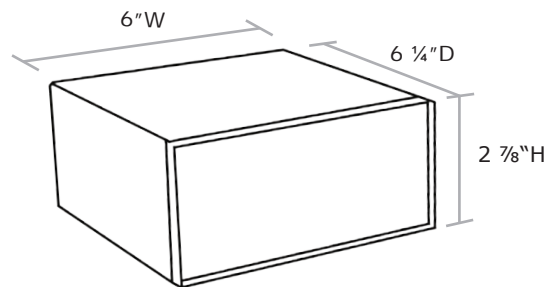

Part #	Description	Input	Output	Amp Draw	Frequency	Weight	Approvals
LCS770	200 watt siren with light controls	10-16V DC	100 or 200 watts 1 or 2 speakers	8 amps per speaker	675-3000Hz	7 lbs.	Exceeds acoustical and environmental requirements, SAE J1849, California Title 13

Warning: Cancer and Reproductive Harm - www.P65Warnings.ca.gov



Toll Free Fax Line: 1-888-478-2797
www.starheadlight.com





Windows Programming Software



Flange Control Head



Flangeless Control Head

LCS850MG12

- Premium full feature 200 watt dual-tone siren and PA with slide switch, push button light controls, and Traffic Director functions
- Seven push button audio functions (Manual, Air Horn, Hands Free, Wail, Yelp, Phaser, Radio Repeat)
- Controls up to eighteen different lights/functions
- Four-position programmable progressive slide switch with LED indicators
- Five lighted push buttons for auxiliary lighting/functions
- Dual Tone (Magnum) Mode allows a single vehicle to sound like several vehicles
- Integrated public address microphone with user adjustable volume knob (combination Volume and On/Off)
- Drives one or two 100 watt speakers
- Over fifty programmable options
- Dual color lighted push buttons (Green/Red)
- Several programmable Gun Lock options
- Park Kill input (positive or negative switched)
- Auxiliary input (positive or negative switched) for Air Horn or Hands Free Tone Cycling
- Select either flange mount or flush mount version
- Diagnostic LEDs allow for quick troubleshooting
- Designed to have 0mA standby current to prevent battery drainage
- Fully protected unit with high and low voltage shutdown, reverse polarity protection, built-in self-resetting audio circuit protection, and user-replaceable fuses
- An optional Windows interface allows you to easily program one siren via USB cable and clone the options to and entire fleet of vehicles.
- Ships complete with positive locking wiring connector, mic clip, hardware, push button labels, and instructions

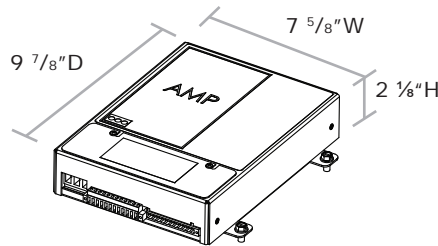

Part #	Description	Input	Output	Amp Draw	Frequency	Weight	Approvals
LCS850MG-F12	Unistar Command Center, siren with flange, Traffic Director capable	10-16V DC	100 or 200 watts 1 or 2 speakers	8 amps per speaker	675-3000Hz	7 lbs.	Exceeds acoustical and environmental requirements, SAE J1849, California Title 13 (when used with SVP drivers and approved audio tones)
LCS850MG12	Unistar Command Center, siren without flange, Traffic Director capable						

Warning: Cancer and Reproductive Harm - www.P65Warnings.ca.gov

Phone Number: 585-226-9500
www.starheadlight.com





LCS850-8



LCS800

LCS800-008, LCS850-8



back

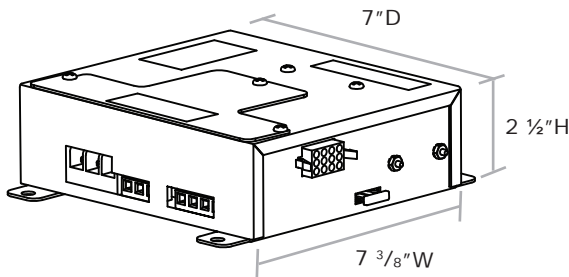

- Full feature 200 watt siren with remote mounted amplifier, slide switch, and push button lighting controls
- Seven Push Button Audio Functions (Manual, Air Horn, Hands Free, Wail, Yelp, Phaser, Radio Repeat)
- Controls up to eight different lights/functions
- Four-position programmable progressive slide switch with LED indicators
- Five lighted push buttons for auxiliary lighting/functions
- LCS850-8 also includes Traffic Director capabilities
- Integrated public address microphone
- Drives one or two 100-watt speakers
- Dual color lighted push buttons (Amber/Red)
- Gun Lock Option
- Park Kill input (positive or negative switched)
- Auxiliary input (positive or negative switched) for Air Horn or Hands Free Tone Cycling
- Diagnostic LEDs allow for quick troubleshooting
- Fully protected unit with high and low voltage shutdown, reverse polarity protection, built-in self-resetting audio circuit protection, and user-replaceable fuses
- Ships complete with positive locking wiring connector, mic clip, U-bracket, hardware, push button labels, and instructions

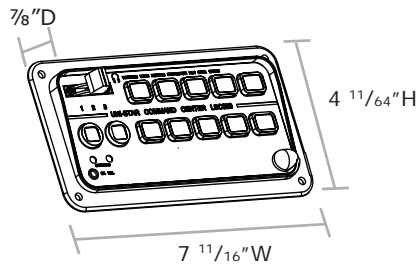

Flange Mount

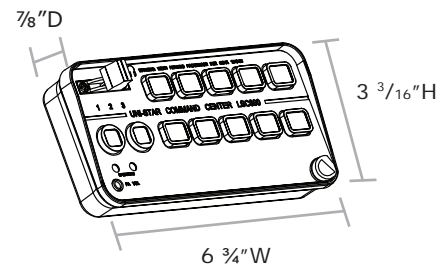

Flangeless Mount

Part #	Description	Input	Output	Amp Draw	Frequency	Weight	Approvals
LCS800-008	Full feature siren with light control	10-16V DC	100 or 200 watts 1 or 2 speakers	8 amps per speaker	675-3000Hz	8.5 lbs.	Exceeds acoustical and environmental requirements, SAE J1849, California Title 13, Class A (when used with StarSignal drivers and approved audio tones)
LCS800-F8	Full feature siren with light control, flange mount						
LCS850-8	Full feature siren with light control and Traffic Director						
LCS850-F8	Full feature siren with light control and Traffic Director, flange mount					9.5 lbs.	

Warning: Cancer and Reproductive Harm - www.P65Warnings.ca.gov



Toll Free Fax Line: 1-888-478-2797
www.starheadlight.com





LCS880-016

- Full feature 200 watt siren with hand-held controller/microphone, remote mounted amplifier, and lighting controls.
- Four Audio Push Buttons: Manual, Air Horn, Tone Cycle (Wail, Yelp, Phazer/Two-Tone), and Radio Repeat
- Up to four push button 20 amp lighting outputs and three progressive push button outputs
- Drives one or two 100 watt speakers
- Integrated public address microphone
- Dual color backlighting on keypad (Amber and Red)
- Gun Lock option
- Logic Controlled Traffic Director compatibility
- Positive or negative switching for Auxiliary and Park Kill inputs
- LED speaker diagnostics
- High and low voltage shut down protection
- Self-resetting circuit protection against speaker shorts
- Ships complete with positive locking wiring connector, mic cradle, hardware, push button, and instructions

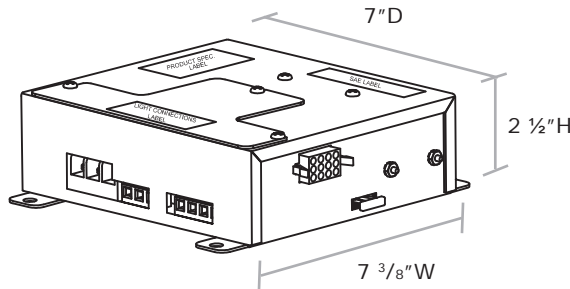
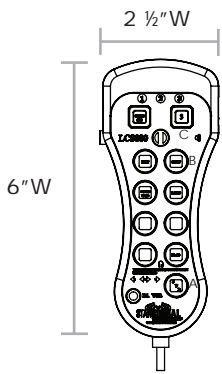

Part #	Description	Input	Output	Amp Draw	Frequency	Weight	Approvals
LCS880-016	Full feature handheld siren with light controls Traffic Director function, cradle, siren amplifier	10-16V DC	100 or 200 watts 1 or 2 speakers	8 amps per speaker	675-3000Hz	8.5 lbs.	Exceeds acoustical and environmental requirements, SAE J1849, California Title 13 (when used with StarSignal driver(s) and approved audio tones)

Warning: Cancer and Reproductive Harm - www.P65Warnings.ca.gov

Phone Number: 585-226-9500
www.starheadlight.com





**LCS869
Controller**



**SS867
Controller**



Amplifier

LCS869, SS867

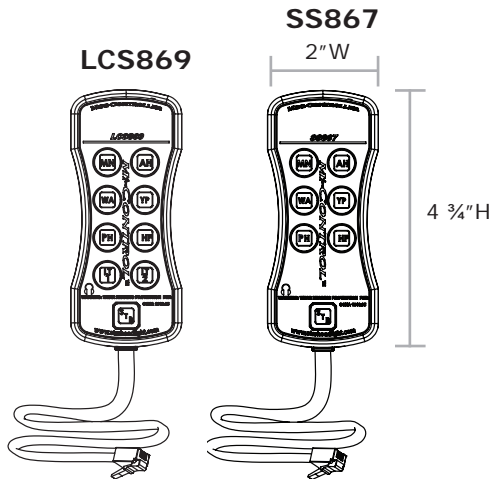
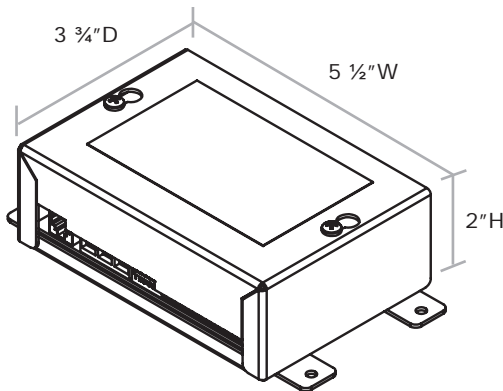

- Full feature 100 watt siren with hand-held controller and remote mounted amplifier
- LCS869 also includes two push button lighting control
- Twenty-two siren tones, including Simulated Mechanical and Manual Wail
- Four Air Horn tones
- "Hands Free" three tone cycle (tone 1, tone 2, tone 3, off)
- Programmable for Air Horn tones only mode (locks out siren tones)
- Auxiliary horn input (positive or negative output)
- Mi-Control™ Series sirens are ideal in situations where the need for high performance features meet limited space
- Mini-Siren controllers are compact yet packed with useful features that will satisfy technical enthusiasts
- Choose the Mi-Control™ SS867 for full feature siren control or Mi-Control™ LCS869 for full feature light and siren control combination
- Over/under voltage, speaker short protection, and visual feedback
- Forty-nine changeable button labels
- All button back lit by Green Off/Red On LEDs
- Off/Stand-by button
- Lighting features: standard (push On/push Off), two outputs, max 30 amps per output and total for system or four functionality options - eight second timer (aka Gun Lock), momentary, normally closed

Part #	Description	Input	Output	Amp Draw	Frequency	Weight	Approvals
LCS869	100 watt 9 button hand held controller with six siren and two light function	10-16V DC	100 watts 1 speaker	8 amps	675-3000Hz	2.5 lbs.	Exceeds acoustical and environmental requirements, SAE J1849, California Title 13 (when used with StarSignal drivers and approved audio tones)
SS867	100 watt, 7 button hand held siren controller					6 lbs.	

Warning: Cancer and Reproductive Harm - www.P65Warnings.ca.gov



Toll Free Fax Line: 1-888-478-2797
www.starheadlight.com



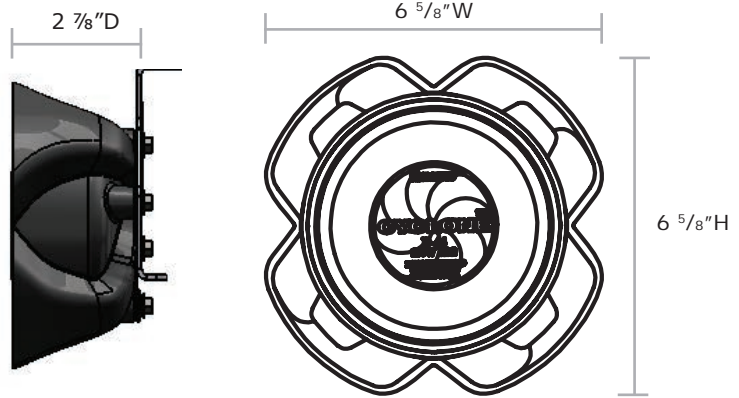

D-44 Cyclone Speaker

- Patented Cyclonic Expansion Chambers (Patent #8,265,320 B2 D615,4435)
- Ultra compact design - less than 3" deep
- Rugged glass filled nylon housing - will not rust!
- User replaceable rear facing driver
- Mounting bracket options

Part #	Description	Nominal Input Voltage	Max Input Power	Impedance	Weight	Approvals
D-44	Speaker only	32V RMS	100 watts	11 ohm	8 lbs.	Meets or Exceeds Acoustical Requirements SAE J1849 and Title 13 when used with a Star siren, Meets or Exceeds Environmental requirements of SAE J1849

Part #	Description
SPBRK-16	Universal "L" bracket, '04 - '05 Dodge Durango, '01 Ford Taurus, '02 - '09 Ford Explorer, '04 - '09 GMC Envoy, '02 - '13 Chevy Avalanche, '02 - '09 Chevy Suburban, '04 - '06 Chevy Tahoe
SPBRK-17	Center mount bracket, '03 - '11 Ford Crown Victoria
SPBRK-18	'07 - '15 Chevy Suburban, '07 - '15 Chevy Tahoe
SPBRK-19	'06 - '03 Chevy Impala
SPBRK-20	'06 - '10 Dodge Charger
SPBRK-21	Universal two piece adjustable bracket
SPBRK-22L	'08 - '20 Ford F-series Super Duty, driver side
SPBRK-22R	'08 - '20 Ford F-series Super Duty, passenger side
SPBRK-23	'08 - '20 E-350/450
SPBRK-24	'07 - '15 Ford Expedition
SPBRK-27	'11 - '22 Dodge Charger
SPBRK-28	'10 - '20 Ford Taurus

Part #	Description
SPBRK-29	'11 - '15 Ford 350
SPBRK-30	'11 - '15 Dodge 4500
SPBRK-31	'11 - '18 Chevy Caprice
SPBRK-32	'11 - '22 dual bracket for Dodge Charger
SPBRK-33	'10 - '22 Dodge Durango
SPBRK-34	'10 - '22 dual bracket for Interceptor SUV
SPBRK-35	'15 - '20 single bracket for Chevy Tahoe and Suburban
SPBRK-36	'15 - '20 dual bracket for Chevy Tahoe and Suburban
SPBRK-37	'15 - '22 Ford F-150
SPBRK-38	'10 - '22 dual bracket for Dodge Durango
SPBRK-39	'20 - '22 single bracket for Dodge Ram
SPBRK-40	'21 - '22 single bracket for Chevy Tahoe
SPBRK-41	'21 - '22 dual bracket for Chevy Tahoe
SPBRK-42	Single/Dual bracket for '22 Ford F150

Warning: Cancer and Reproductive Harm - www.P65Warnings.ca.gov

Phone Number: 585-226-9500
www.starheadlight.com





D-60-RBS



D-60



D-60-RBB

Speakers

- All StarSignal® speakers are 100 watt, 11 ohms, and include a low profile driver, mounting brackets, hardware and instructions

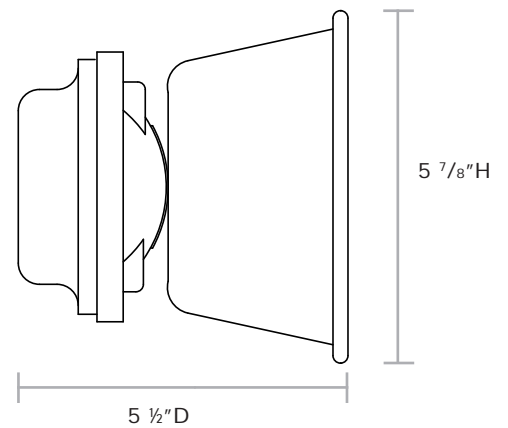

Part #	Description	Nominal Voltage	Max Input Power	Impedance	Weight	Approvals
D-60	Standard regular speaker, ABS plastic housing	32V RMS	100 watts	11 ohms	8 lbs.	Meets or Exceeds Acoustical Requirements (SAE J1849 and Title 13 when used with a Star siren)
D-60-RBB	Compact speaker with Aluminum housing for Motorcycles, Gloss Black					
D-60-RBS	Compact speaker with Aluminum housing for Motorcycles, Electropolished Silver					

Warning: Cancer and Reproductive Harm - www.P65Warnings.ca.gov



Toll Free Fax Line: 1-888-478-2797
www.starheadlight.com



510	81
511	81
1300 Series	64
1400 Series	64
1401-ES-AA	65
1421-ES-RB	65
1421LED-RB	64
1500 Series	64
1501-ES-AA	65
1521-ES-RB	65
1521LED-RB	64
1550 Series	64
1550-TB10-Y	66
1550-TB12-Y	66
1550-TB8-YR	66
1600 Series	64
200A-12V.*	4
200AH8L.*	10
200AHDL.**	13
200AHL.*	10
200S-12V.*	5
200SH8L.*	11
200SH8LM.*	11
200SHDL.**	14
200SHDLM.**	14
200SHL.*	11
200SHLM.*	11
200SM-12V.*	5
201ZL	18
201ZLM	18
201ZLX.*	7
201ZLXM.*	7
203MVL.*	19
203MVLM.*	19
204MVL.*	20
240C-12V.*	6
240CF-12V.*	6
240CFL.*	17
240CM-12V.*	6
240H8AFL.*	12
240H8AL.*	12
240H8ALM.*	12
240H8CFL.*	12
240H8CGL.*	12
240H8CL.*	12
240H8CLM.*	12
240H8SFL.*	12
240H8SGL.*	12
240H8SL.*	12
240H8SLM.*	12
240HCFL.*	12
240HCGL.*	12

240HCL.*	12
240HCLM.*	12
240HSFL.*	12
240HSGL.*	12
240HSL.*	12
240HSLM.*	12
240S-12V.*	6
240SF-12V.*	6
240SFL.*	17
240SM-12V.*	6
255H8TAL-A	8
255H8TALV-A	8
255H8TCFL.*	8
255H8TCL.*	8
255H8TCLM.*	8
255H8TCLV.*	8
255H8TSFL.*	8
255H8TSL.*	8
255H8TSLM.*	8
255H8TSLV.*	8
255HTAL-A	8
255HTALV-A	8
255HTCFL.*	8
255HTCL.*	8
255HTCLM.*	8
255HTCLV.*	8
255HTSFL.*	8
255HTSL.*	8
255HTSLM.*	8
255HTSLV.*	8
256TCFL.*	16
256TCL.*	16
256TCLM.*	16
256TCLV.*	16
256TSFL.*	16
256TSL.*	16
256TSLM.*	16
256TSLV.*	16
257H8TAL-A	9
257H8TALV-A	9
257H8TCL.*	9
257H8TCLV.*	9
257H8TSL.*	9
257H8TSLV.*	9
257HTSLV.*	9
257HTAL-A	9
257HTALV-A	9
257HTCL.*	9
257HTCLV.*	9
257HTSL.*	9
258HTDAL.**	15
258HTDALV.**	15

258HTDCL.**	15
258HTDCLV.**	15
258HTDSL.**	15
258HTDSL.V.**	15
266TAL.*	2
266TASL.*	2
266TCFL.*	2
266TCL.*	2
266TCLM.*	2
266TCLV.*	2
266TSFL.*	2
266TSL.*	2
266TSLM.*	2
266TSLV.*	2
274-DLIT3-U	27
274-DLIT-45	27
274-DLIT-CLP	27
274-DLIT-GRL	27
274-DLIT-GTA	27
274-DLIT-LPB4	27, 30
274-DLIT-RB	27
274-DLIT-RL	27
274-DLIT-RT	27
274-DLIT-U	27
274-DLIT-W	27
274-DLX4-6-1X2	30
274-DLX4-6-2X1	30
274-DLX4-6-45	30
274-DLX4-6-CLP	30
274-DLX4-6-H	30
274-DLX4-6-HK	30
274-DLX4-6-RL	30
274-DLX4-6-T	30
274-DLX4-6-U	30
274-DLX4-6-W	30
274-DLXT-1X2	34
274-DLXT-2X1	34
274-DLXT-45	34
274-DLXT-RL	34
274-DLXT-T	34
274-DLXT-U	34
274-DLXT-W	34
274-LMB	81
274-SL	81
274-SL1	81
274-ULB10-CH11	53
274-ULB10-CP	53
274-ULB10-DU	53
274-ULB10-EX	53
274-ULB10-F1	53
274-ULB10-INT	53
274-ULB10-RM	53

274-ULB10-TA	53
274-ULB10-U	53
274-ULB21-CH11	53
274-ULB21-CP	53
274-ULB21-DU	53
274-ULB21-EPD20	53
274-ULB21-EX	53
274-ULB21-EX20	53
274-ULB21-F1	53
274-ULB21-INT	53
274-ULB21-RM	53
274-ULB21-RM20	53
274-ULB21-TA	53
274-ULB21-TA21	53
274-ULB21-U	53
274-ULB21-U1	53
274-ULB42BKT	49
281.*	3
281B.*	3
281DIN.*	3
281FDIN.*	3
281M.*	3
281R.*	3
281RFP.*	3
281RM.*	3
281RP.*	3
500-J	81
510-1	81
510-1M	81
510-4509	81
510-M	81
511-1M	81
60-087	71
60-097	71
60-097DT	71
60-102	71
60-102DT	71
60-107	71
60-707A	71
60-802A	71
60-802S	71
60-807A	71
60-907S	71
63-087	72
63-097	72
63-097DT	72
63-102	72
63-102DT	72
63-107	72
63-707A	72
63-802A	72
63-807A	72

64-097	74
64-102	74
64-107	74
66-087	73
66-087SS	76
66-092SS	76
66-097	73
66-097DF	73
66-097DT	73
66-097SS	76
66-102	73
66-102DT	73
66-107	73
66-707A	73
66-802A	73
66-802S	73
66-807A	73
66-907S	73
66L-087	73
66L-097	73
66L-097DT	73
66L-097SS	76
66L-102	73
66L-102DT	73
66L-107	73
66L-707A	73
66L-802A	73
66L-807A	73
68-112	75
68-812A	75
68C-112	75
68C-812A	75
68L-112	75
68L-812A	75
7100DLED.*	60
7100LED.*	60
7100LED-TB.*	60
7400 Series	67
7500 Series	67
7600 Series	67
7650-TB10-Y	68
9016LED.*	59
9016LEDM.*	59
9016LEDV.*	59
9018DLED.*	56
9018LED.*	56
9018LED9-A	56
9018LEDV.*	56
9100DLED.*	58
9100DLEDM.*	58
9100DLEDV.*	58
9100LED.*	57

 **Warning:** Cancer and Reproductive Harm - www.P65Warnings.ca.gov

Phone Number: 585-226-9500
www.starheadlight.com



9100LEDM-*	57
9100LEDV-*	57
9200H8L-*	63
9200H8LM-*	63
9200H8LV-*	63
9200HL-*	63
9200HLM-*	63
9200HLV-*	63
9200LX-*	62
9200LXM-*	62
9200LXV-*	62
9202L-*	61
9202LM-*	61
9202LV-*	61
920-35	70
920-35CH	69
920-35CVLP	70
920-35D	69
920-35DU20	69
920-35F	69, 70
920-35F1	70
920-35F10	70
920-35F2	70
920-35F3	70
920-35F5	70
920-35F6	70
920-35F9	70
920-35FT	70
920-35FX1	69, 70
920-35FX2	69, 70
920-35FX3	70
920-35GM	69
920-35GM5	69
920-35GM6	69
920-35GM7	69
920-35GM8	69
920-35I6	69
920-35M1	69
920-35RM2	69
920-35RM3	69
920-35RM5	69
920-35-S105	69
9900LED-*	54
9900LEDB-*	54
9900LEDV-*	54
9901LED	55
BB274-DLX46LPM	30
BB274-DLX4-6-RHK	30
BB274-DLX4-6-SLP	30
BB274-DLX6-BAIL	30
BB274-DLXTHU-LPB	34
BB274-DLXT-LPB	34

BB274-DLX-VC	30
BB274-FISUV-DLIT3	27, 37
BB274-FISUV-VER	37
BB274-RWL	30
BBK274-FH	80
BBK274-FH-P	80
BBK274-FL	80
BBK274-FL-P	80
BBK274-PLATE	80
BK255H8TCL	40
BK255H8TSL	40
BK266TCL	39
BK266TSL	39
BK9016LED	39
BK9100LED	39
BKDLIT3E	38
BKDLIT3S	38
BKDLITE	38
BKDLITS	38
BKDLS306	38
BKDLX3	38
BKDLX4	38
BKDLX6F	38
BKDLXT-121	40
BKDLXTHR	39
BKDLXTHU	39
BKLD418-2	40
BKLDHF311-W-10	38
BKSWH-346-10	40
BKSWH-346-18	40
BKSWH-346-19	40
BKSWH-346-24	40
BKSWH-346-5	40
BKSWH-357-18	40
BKSWH-357-23	40
BKSWH-361-10	40
BKSWH-361-14	40
BKSWH-361-16	40
BKSWH-361-18	40
BKSWH-361-21	40
BKSWH-361-21FD	40
BKSWH-361-23	40
BKSWH-361-25	40
BKSWH-361-FD-S	40
D-44	94
D-60	95
D-60-RBB	95
D-60-RBS	95
DLHT-121-*	33
DLHT-121C**	33
DLHT-124-*	33
DLHT-124C**	33

DLHT-241-*	33
DLHT-241C**	33
DLHT-244-*	33
DLHT-244C**	33
DLITDC-*	24
DLIT3E-*	25
DLIT3S-*	25
DLITE-*	25
DLITMC-***	26
DLITS-*	25
DLNT-121-*	33
DLNT-121S**	33
DLNT-121SC**	33
DLNT-122S**	33
DLNT-122SC**	33
DLOS3-6-*	42
DLOS3-6-**-3	42
DLOS3-8-*	42
DLOS3-8-**-3	42
DLOS-4-*	42
DLOS-47-AA	42
DLOS-56-*	42
DLOS-6-*	42
DLOS-6-AA-TD	42
DLOS-76-*	42
DLOS-8-*	42
DLOS-8-AA-TD	42
DLQS-ARO-*	43
DLQS-ARO2-*	43
DLQS-ARO2-AA-TD	43
DLQS-ARO-AA-TD	43
DLQSMC-4-*	45
DLQSMC-6-*	45
DLQSMC-8-*	45
DLQSMC-ARO2-CUST	44
DLQSMC-ARO2-CUST-TD	44
DLQSMC-ARO-CUST	44
DLQSMC-ARO-CUST-TD	44
DLS306-*	28
DLS306C-*	28
DLTT-121-*	33
DLTT-124-*	33
DLTT-241-*	33
DLTT-244-*	33
DLTTRMC-1	32
DLTTRMC-4	32
DLX3-*	29
DLX4-*	29
DLX4C-*	29
DLX4-HK-*	31
DLX4-HK-1-*	31
DLX4-HK2-*	31

DLX4-HK2-1-*	31
DLX6-*	29
DLX6C-*	29
DLX6F-*	29
DLX6-HK-*	31
DLX6-HK-1-*	31
DLX6-HK2-*	31
DLX6-HK2-1-*	31
DLXT-121-*	33
DLXT-121C-*	33
DLXT-124-*	33
DLXT-124C-*	33
DLXT-2CUST	33
DLXT-3CUST	33
DLXTHR-1-*	35
DLXTHR-2-*	35
DLXTHR-4-*	35
DLXTHR-8-*	35
DLXTHU-1-*	35
DLXTHU-2-*	35
DLXTHU-4-*	35
DLXTHU-7-*	35
DLXTHU-8-*	35
DLXTHUS-1-*	35
DLXTHUS-4-*	35
DLXTRMC-1-*	32
DLXTRMC-1C-*	32
DLXTRMC-4-*	32
DLXTUMC-1-*	32
DLXTUMC-1C-*	32
DLXTUMC-4-*	32
LCS652-013	88
LCS653-013	88
LCS653-1-013	88
LCS770	89
LCS800-008	91
LCS800-F8	91
LCS850-8	91
LCS850-F8	91
LCS850MG12	90
LCS850MG-F12	90
LCS869	93
LCS880-016	92
LDH-361-S-*	36
LDH-361-T-*	36
LDH-362-E-*	36
LDH-362-S-*	36
LDH-362-T-*	36
LDH-363-E-*	36
LDH-363M-S-*	36
LDH-363M-T-*	36
LDH-363-S-*	36

LDH-363-T-*	36
LDH-364-E-*	36
LDH-364-S-*	36
LDH-364-T-*	36
LDHF301-**-10	41
LDHF301-**-30	41
LDHF311-**-10	41
LDHF311-**-30	41
LDHF362-E-*	36
LDHF362-S-*	36
LDHF362-T-*	36
LDHF363-E-*	36
LDHF363-SE-*	36
LDHF363-T-*	36
LDHF364-E-*	36
LDHF364-T-*	36
RLKULB9E-1-*	21
RLKULB9S-1-*	23
SB1515	77
SB3015	77
SB4020	77
SB4020-15	77
SB4020T	77
SB4040	77
SB4040-15	77
SB4425T	77
SB44-5	78
SB44-8	79
SP1515	77
SP3015	77
SP3860-1	77
SP3860-2	77
SP3860-2H	77
SP3860-3	77
SP3860-3H	77
SP3860-4	77
SP3860-4H	77
SP3860-5	77
SPBRK-16	94
SPBRK-17	94
SPBRK-18	94
SPBRK-19	94
SPBRK-20	94
SPBRK-21	94
SPBRK-22L	94
SPBRK-22R	94
SPBRK-23	94
SPBRK-24	94
SPBRK-27	94
SPBRK-28	94
SPBRK-29	94
SPBRK-30	94

 **Warning:** Cancer and Reproductive Harm - www.P65Warnings.ca.gov



Toll Free Fax Line: 1-888-478-2797
www.starheadlight.com



SPBRK-31	94
SPBRK-32	94
SPBRK-33	94
SPBRK-34	94
SPBRK-35	94
SPBRK-36	94
SPBRK-37	94
SPBRK-38	94
SPBRK-39	94
SPBRK-40	94
SPBRK-41	94
SPBRK-42	94
SR10	81
SR12	81
SR7	81
SR9	81
SS650-013	87
SS651-013	87
SS651MT-013	86
SS670-013	82
SS700-016	83
SS700-28-016	83
SS730	84
SS741MG-11	85
SS867	94
TCS-1	46
TCS-1REF	46
TCS-2	46
TCS-2REF	46
TCS-6	46
ULB14	50
ULB18	51
ULB24	50
ULB24-DLP	50
ULB28	51
ULB28-CH	52
ULB28-FIS	52
ULB28-FISUV	52
ULB34-1-FISUV**	47
ULB34-1-FISUV20**	47
ULB34-1-TA21.**	47
ULB38-TD-FISUV	48
ULB38-TD-FISUV20	48
ULB38-TD-TA21	48
ULB48-TD	49
ULB9E.**	21
ULB9E-1.**	21
ULB9LDC.**	22
ULB9LDC-1.**	22
VL22	23

 **Warning:** Cancer and Reproductive Harm - www.P65Warnings.ca.gov

Phone Number: 585-226-9500
www.starheadlight.com



Terms and Warranty

Sales Policy

All Star Headlight & Lantern Co., Inc. products are sold through distributors. Possession of our catalog and/or price list does not constitute our offer to sell to or the right to purchase directly from Star Headlight & Lantern Co., Inc.

Returns

You must contact Star Headlight & Lantern Co., Inc. prior to return any merchandise. All returns require a Return Material Authorization (RMA) number. The RMA# must be clearly marked on the package and associated paperwork. All returned merchandise is subject to inspection. Any items returned for repair that are deemed to be out of warranty are subject to parts replacement cost. If a returned item is out of warranty, the sender will be notified prior to any work being performed with an estimated cost of repair. No repairs will be done until proper authorization is obtained from the sender. Any merchandise returned for restock/credit that is not in new and sale-able condition will be returned to the distributor issued and no credit will be issued. All items returned for restock are subject to a 15% restocking fee.

Installation

It is the sole responsibility of the owner to ensure their warning light is secure. Check the light every time you use the vehicle to ensure that it is mounted securely. Star Headlight & Lantern Co., Inc. assumes no responsibility for the secure mounting of this light on the roof of your vehicle with a magnet mount, take extreme care to ensure that the magnet is firmly seated on your roof, and that the pull of the magnet is sufficient to secure the light in place. As the composition of the metal in the roofs of different vehicles may vary, as well as the contour, texture and/or conditions, Star Headlight & Lantern Co., Inc. cannot guarantee the ability of any magnetically mounted light to remain in place upon a moving vehicle and it is done at the sole discretion of the owner.

Warranty

The manufacturer warranties each new product, under normal use, against factory defects in material and workmanship for one year and five years on LED components after the date purchase. The owner will be responsible for returning to the Service Center any defective item(s) with the transportation costs prepaid. The manufacturer will, without charge, repair or replace at its option, products, or part(s), which its inspection determines to be defective. Repaired or replacement item(s) will be returned to the purchaser with transportation costs prepaid from the service point. A copy of the purchaser's receipt must be returned with the defective item(s) in order to qualify for the warranty coverage. Exclusions from this warranty include, but are not limited to, bulbs, strobe tubes, domes, and/or the finish. This warranty shall not apply to any light, which has been altered, such that in the manufacturer's judgment, the performance or reliability has been affected, or in any damage has resulted from abnormal use or service. This warranty does not apply to defect or damage occurring as a result of disaster, accident, abuse, misuse, lightning, power surges, or failure to follow enclosed manuals.

Any damage or defects occurring as a result of any unauthorized service or repairs by unauthorized persons shall be excluded from this warranty. There are no warranties expressed or implied (including any warranty of merchantability or fitness), which extend this warranty period. The loss of use of the product, loss of time, inconvenience, commercial loss or consequential damages, including the cost of any labor, are not covered. The manufacturer reserves the right to change the design of the product without assuming any obligation to modify any product previously manufactured. This warranty gives you specific legal rights. You might also have additional rights which may vary from state to state. Some states do not allow limitations on how long and implied warranty lasts. Some states do not allow the exclusion or limitation of incidental damages. Therefore, the above limitation(s) or exclusion(s) may not apply to you.

Notes

Bulbs and flash tubes are not covered under warranty. Speakers are not covered against water damage.

 **Warning:** Cancer and Reproductive Harm - www.P65Warnings.ca.gov



Toll Free Fax Line: 1-888-478-2797
www.starheadlight.com



